



MESSAGE DELAY IN COMMUNICATION NETS WITH STORAGE

by

LEONARD KLEINROCK

B. E. E., City College of New York (1957)

S. M., Massachusetts Institute of Technology (1959)

SUBMITTED IN PARTIAL FULFILLMENT OF THE
REQUIREMENTS FOR THE DEGREE OF
DOCTOR OF PHILOSOPHY

at the

MASSACHUSETTS INSTITUTE OF TECHNOLOGY

December 1962

Signature of Author ...
Department of Electrical Engineering, December 1962

Certified by ...
Thesis Supervisor

Accepted by ...
Chairman, Departmental Committee on Graduate Students

MESSAGE DELAY IN COMMUNICATION NETS WITH STORAGE

by

LEONARD KLEINROCK

Submitted to the Department of Electrical Engineering in December 1962 in partial fulfillment of the requirements for the degree of Doctor of Philosophy.

ABSTRACT

This thesis investigates the flow of message traffic in communication nets in which there is storage at each of the nodes in the net. The measure of performance used is the average delay experienced by a message as it passes through the net. The results of this study expose the effects of channel capacity assignment, routing procedure, priority discipline, and topological structure on the average message delay, subject to the constraint that the sum of all channel capacities in the net is a constant. The input traffic is assumed to have Poisson arrival time statistics, with exponentially distributed message lengths. Furthermore, an assumption regarding the independence of the inter-arrival times and message lengths of the internal traffic statistics is made which simplifies the mathematical analysis; this assumption leads to a model which closely approximates the behavior of the average message delay for nets with dependent traffic (i. e., in the absence of the independence assumption).

Certain new results for simple multiple channel systems indicate that message delay is minimized when the message traffic is clustered into a small number of high capacity channels. The optimum channel capacity assignment (which minimizes an expression for the average message delay) is derived for a communication net with a fixed routing procedure, and subject to the constraint of constant total channel capacity. An analysis for a new delay dependent priority structure is carried out, which provides the system designer with a number of degrees of freedom with which to adjust the relative waiting times for each priority group. Furthermore, a conservation law is developed which allows one to draw a number of general conclusions about the average waiting times for a large class of priority structures.

A class of random routing procedures, described by finite-dimensional, irreducible circulant probability transition matrices is investigated, and the average path length is solved for; a solution for the expected message delay under such routing procedures is also obtained. It is found that random routing results in increased message delay and decreased total traffic handling capability.

A digital network simulation program was written, and its operation is described. The major results from the simulation are summarized below:

- (1) The square root channel capacity assignment assigns to each channel enough capacity to handle its average traffic flow, and then assigns the excess capacity in proportion to the square root of the traffic carried by that channel. This assignment results in superior performance as compared to a number of other channel capacity assignments in various nets.

- (2) The performance of a straightforward fixed routing procedure, with the square root capacity assignment, surpasses that of simple alternate routing procedures.
- (3) Alternate routing procedures adapt the internal traffic flow to suit the capacity assignment (i. e., the bulk of the message traffic is routed to the high capacity channels). This effect is especially noticeable and important in the case of a poor capacity assignment which may come about due to uncertainty or variation in the applied message traffic.
- (4) A high degree of non-uniformity in the external traffic matrix results in improved performance for the case of a square root channel capacity assignment.
- (5) The quantities essential to the determination of the average message delay are the average path length and the degree to which the traffic flow is clustered. The trade-off between these two quantities allows one to determine the sequence of optimal network topologies which ranges from the star net at small values of network load to the fully connected net as the network load approaches unity.

The generalization of certain theorems, and the relaxation of some of the assumptions are discussed in order to indicate appropriate extensions to this study.

Thesis Supervisor: Edward Arthurs
Title: Assistant Professor of Electrical Engineering

ACKNOWLEDGMENT

I would like to express my appreciation to Professor Edward Arthurs for his encouragement and guidance in the supervision of this thesis. I am also indebted to Dr. Herbert P. Galliher, Jr. of the Operations Research Center and to Professor Claude E. Shannon, for their suggestions and ideas which proved invaluable.

In addition, I wish to express my thanks to the Massachusetts Institute of Technology, Lincoln Laboratory,* for the interest and encouragement offered to me as a Staff Associate and also for the use of the TX-2 digital computer which was made available to me. The informative discussions with numerous members of the M.I.T. and Lincoln Laboratory community were extremely useful, and are deeply appreciated.

In conclusion, I take great pleasure in thanking Gail, my wife, for the encouragement and patience which she has so generously provided.

* Operated with support from the U.S. Army, Navy and Air Force.

TABLE OF CONTENTS

ABSTRACT	ii
ACKNOWLEDGMENT	iv
TABLE OF CONTENTS	v
LIST OF FIGURES	ix
CHAPTER I INTRODUCTION	1
Sect. 1.1 Elementary Concepts	1
1.2 The Quantities of Interest	4
1.3 Description of an Existing Store-and-Forward Communication Net	5
1.4 Assumptions	11
1.5 Notation and Definitions	14
1.6 Summary of Results	16
1.6.1 Analytic Results	16
1.6.2 Experimental Results	22
CHAPTER II HISTORY OF THE PROBLEM	27
CHAPTER III THE PROBLEMS OF AN EXACT MATHEMATICAL SOLUTION TO THE GENERAL COMMUNICATION NET	33
3.1 Discussion of the General Problem	33
3.2 The Tandem Net	40
3.3 The Two Node Tandem Net	50
3.4 The Independence Assumption	56
3.5 The Effect of the Independence Assumption	58
3.6 Summary	66

CHAPTER IV	SOME NEW RESULTS FOR MULTIPLE CHANNEL SYSTEMS	68
Sect. 4.1	A Canonic Representation for the Utilization Factor	69
4.2	Optimum Number of Channels for a Single Node Facility	71
4.3	Trading Relations Among Rate, Capacity, and Message Delay	73
4.4	Optimum Assignment of Channel Capacity	76
4.5	Conclusions and Extensions	83
CHAPTER V	WAITING TIMES FOR CERTAIN QUEUE DISCIPLINES	86
5.1	Priority Queueing	87
5.2	A Conservation Law	103
5.3	Time Shared Service	106
5.4	Conclusions and Extensions	116
CHAPTER VI	RANDOM ROUTING PROCEDURES	120
6.1	Markov Model - Circulant Matrices	122
6.2	The Average Path Length	125
6.3	Examples of Nets Included by the Model	128
6.4	The K-connected Communication Net	130
6.5	Conclusions	133
CHAPTER VII	SIMULATION OF COMMUNICATION NETS	137
7.1	Specific Network Descriptions	137
7.2	Simulation Results	149
7.3	Additional Theorems on Alternate Routing Procedures	161
7.4	Conclusions	163
CHAPTER VIII	CONCLUSION	166
8.1	Summary	166
8.2	Suggstions for Further Investigations	169

APPENDIX A	REVIEW OF SIMPLE QUEUEING SYSTEMS	172
A. 1	Birth and Death Equations - Exponential Assumptions	173
A. 2	The Single Exponential Channel	175
A. 3	Multiple Exponential Channels	180
A. 4	The Output of a Queueing Process	182
APPENDIX B	THEOREMS AND PROOFS FOR CHAPTER IV	183
B. 1	Theorem 4.1 and its proof	183
B. 2	Theorem 4.2 and its proof	185
B. 3	Theorems 4.3, 4.5, and 4.6, and their proofs	186
B. 4	Theorem 4.4 and its proof	191
APPENDIX C	THEOREMS AND PROOFS FOR CHAPTER V	194
C. 1	The Conservation Law (Theorem 5.4) and its proof	196
C. 2	Corollaries to the Conservation Law and their proofs	201
C. 3	Theorem 5.1 and its proof	207
C. 4	Theorem 5.2 and its proof	210
C. 5	Theorem 5.3 and its proof	220
C. 6	Theorem 5.5 and its proof	222
C. 7	Theorem 5.6 and its proof	227
C. 8	Theorem 5.7 and its proof	231
APPENDIX D	THEOREMS AND PROOFS FOR CHAPTER VI	233
D. 1	Definitions and Derived Expressions for \bar{n}	233
D. 2	Theorem 6.1 and its proof	235
D. 3	Proof of Eqs. 6.6 and 6.7	241
D. 4	Theorem D.1 and its proof	242
D. 5	Theorem 6.2 and its proof	247
D. 6	Theorem 6.3 and its proof	252

APPENDIX E	AN OPERATIONAL DESCRIPTION OF THE SIMULATION PROGRAM	253
APPENDIX F	ALTERNATE ROUTING THEOREMS AND THEIR PROOFS	260
F.1	Theorem 7.1 and its proof	260
F.2	Theorem 7.2 and its proof	263
BIBLIOGRAPHY		267
BIOGRAPHICAL NOTE		270

LIST OF ILLUSTRATIONS

Fig. 1.1	Example of a 5 node net.	1
1.2	The star net configuration.	24
3.1	A two node tandem net.	37
3.2	Adjacent messages leaving node 1.	38
3.3	The tandem net with K nodes.	40
3.4	Example of $U_k(t)$ for the first three tandem nodes.	41
3.5	Simulated nets for studying internal network traffic.	59
3.6	Histograms of message delay from digital simulation (the histograms pertain to delay in the black nodes).	61
3.7	Average message delay for nets in Fig. 3.5.	63
3.8	Effect of the Independence Assumption (non-uniform traffic).	64
3.9	Effect of the Independence Assumption (uniform traffic).	65
4.1	N -channel node considered in Theorem 4.2.	72
4.2	Two single exponential channel facilities.	73
4.3	Trading curves among message delay, channel capacity, and total traffic handled.	75
4.4	System of N separate single channel facilities.	77
5.1	Interaction between priority functions for the delay dependent priority system.	93
5.2	$\mu W_p(\rho)$ for the fixed priority system with no pre-emption	97
	(a) $P = 2$	
	(b) $P = 5$	
	(c) $P = 2$, expanded scale	
	(d) $P = 5$, expanded scale	
5.3	$\mu W_p(\rho)$ for the fixed priority system with pre-emption	99
	(a) $P = 2$	
	(b) $P = 5$	
	(c) $P = 2$, expanded scale	
	(d) $P = 5$, expanded scale	

Fig. 5.4	$\mu W_p(\rho)$ for the delay dependent priority system with no pre-emption	101
	(a) $P = 2$	
	(b) $P = 5$	
5.5	$\mu W_p(\rho)$ for the delay dependent priority system with pre-emption	102
	(a) $P = 2$	
	(b) $P = 5$	
5.6	The round-robin time shared service system.	107
5.7	$\frac{1-\sigma}{\sigma Q} W_n(\rho)$ for the late arrival time shared service system	113
	(a) $\sigma = 19/20$	
	(b) $\sigma = 4/5$	
	(c) $\sigma = 1/5$	
6.1	The ring net configuration.	128
6.2	The nearest neighbor configuration.	128
6.3	A more general nearest neighbor configuration.	129
6.4	The fully connected net.	129
7.1	The diamond net with its incidence matrix and its complete alternate routing procedure.	142
7.2	Other routing procedures for the diamond net.	143
7.3	The K-connected net ($K=4$).	144
7.4	The fully connected net.	145
7.5	Alternate routing for the fully connected net.	146
7.6	The star net.	147
7.7	Effect of sample size on the average message delay (for the diamond net and traffic matrix τ_1).	148
7.8	Effect of routing procedure and channel capacity assignment on the average message delay for the diamond net.	151
	(a) traffic matrix $\tau_1, \rho = .0625$	
	(b) traffic matrix $\tau_1, \rho = .125$	
	(c) traffic matrix $\tau_1, \rho = .250$	
	(d) traffic matrix $\tau_2, \rho = .178$	

Fig. 7.9	Effect of routing procedure and channel capacity assignment on the average message delay for the fully connected net.	153
	(a) traffic matrix τ_1 , $\rho = .0625$	
	(b) traffic matrix τ_1 , $\rho = .125$	
	(c) traffic matrix τ_1 , $\rho = .250$	
7.10	Effect of network topology on the average message delay for a fixed routing procedure and for the highly non-uniform traffic matrix τ_1 .	155
	(a) square root capacity assignment	
	(b) identical capacity assignment	
7.11	Effect of network topology on the average message delay for a fixed routing procedure and for the uniform traffic matrix τ_3 .	156
	(a) square root capacity	
	(b) identical capacity assignment	
7.12	Effect of adding channels to the star net with a fixed routing procedure, a square root channel capacity assignment, and a uniform traffic matrix τ_3 .	159
7.13	Effect of adding channels to the star net with a fixed routing procedure, a square root channel capacity assignment, and a highly non-uniform traffic matrix τ_1 .	160
A.1	Expected number of messages in the system for the single exponential channel.	179
C.1	Total unfinished work, $U(t)$ in the system.	197
C.2	Diagram of priority, $q_p(t)$, for obtaining g_{ip} .	213
C.3	Diagram of priority, $q_p(t)$, for obtaining f_{ip} .	214
D.1	Variation of r_1 with ρ .	246
E.1	Photograph of the on-line display.	255
E.2	Statistical output display from a typical simulation run.	257
	(a) average queue lengths	
	(b) maximum queue lengths	
	(c) present queue lengths	
	(d) channel utilization	
	(e) histogram of generated message lengths	
	(f) histogram of generated inter-arrival times	
	(g) histogram of total message delay	
F.1	Two equal length alternate paths.	261

CHAPTER I

INTRODUCTION

This thesis is principally concerned with the flow of message traffic in store-and-forward communication nets. Recently, there has been serious interest expressed in this field both for commercial and military application. The object of this work is to provide a basis for understanding and discussing the configuration and operation of a communication net. Such questions as assignment of channel capacity, effect of priority discipline, choice of routing procedure, and design of topological structure are considered in this research.

1.1 Elementary Concepts

In introducing the many concepts associated with communication nets, it is helpful to carry along an example of a specific net; we therefore consider the configuration shown in Fig. 1.1. In this figure, the nodes represent communication centers, which ideally might correspond to switching centers in the cities of the United States or in space-borne communication satellites, etc. The ordered connections, or links, between the nodes represent one-way communication channels, each with their own channel

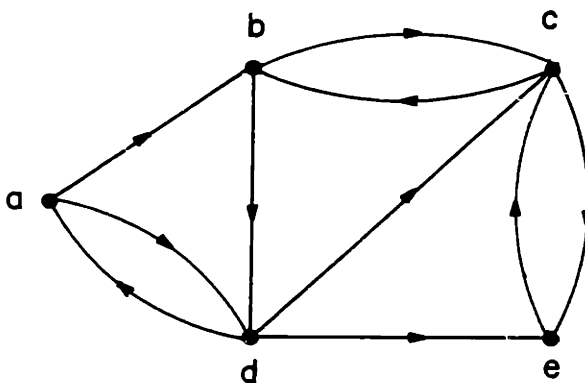

Figure 1.1 Example of a 5 node net.

capacity. For our purposes, messages, which must pass through the net, consist of the specification of the following quantities: the node of origination; the destination node; the time of arrival to the network; the message length in bits*; and the message priority class. In general, these quantities are specified stochastically according to some probability distribution. As an example, suppose that a message originates at node a in Fig. 1.1 at time $t=0$, and has for its destination, node e; let its length be 100 bits, and assume that we have no priority structure associated with the messages. Let us follow this test message through the network. Upon entering node a, a decision must be made as to which of the two neighboring nodes, b or d, the message will next be sent. This decision rule is referred to as a routing procedure, and is, in general, a function of the current state of the net. Channels leaving and entering a node may be used independently and simultaneously, each one for a different message. Thus, when the test message enters node a, it may find zero, one, or two channels in the process of transmitting other messages. If all channels are busy, then the message joins a queue (waiting line) which is accomplished physically by means of storing the message in a memory. The notion of queues of messages forming at the nodes is a basic characteristic of the communication nets under consideration; we may thus think of the communication net as a network of queues. When the message reaches the front of the queue, the routing procedure then decides which channel the message will be sent over. Let us assume that channel \overline{ad} is chosen. If the capacity of this channel is 2 bits per second, then our message will spend 50 seconds in transmission. Clearly, no other message may use the channel during this time. After the transmission is completed, channel \overline{ad} may then accept a new message from the queue for transmission. Upon

* In transmitting messages, we are concerned with the data rate of transmission which is not necessarily the information rate in the information theoretic sense.

reception at node d, the process which took place at node a is essentially repeated, and the message may have to wait on a queue (if all or some of the channels leaving node d are busy). Eventually, however, the message will make its way through the net to its destination at node e. When it arrives at node e, it is considered to be dropped from the net. It is now clear why we refer to these nets as store-and-forward communication nets, viz., in passing through a node, the messages are stored, if necessary, and then forwarded (transmitted) to the next node on the way to their destination. The total time that a message spends in the network is referred to as the message delay. Further, we introduce the concept of a traffic matrix whose ij entry describes the average number of messages generated per second which have node i as an origin, and node j as a destination. The priority classes referred to previously merely dictate the way in which the messages in a queue are ordered (clearly, preferential treatment is given to higher priority messages).

In summary then, we have introduced the following:

- (1) nodes - communication centers which receive, store, and transmit messages.
- (2) links - one-way communication channels.
- (3) network - a finite collection of nodes connected to each other by links.
- (4) messages - specified by their origin, destination, origination time, length, and priority class.
- (5) routing procedure - a decision rule which is exercised when it comes time to route a message from one node to another.
- (6) queue - a waiting line (composed of messages in our case).

- (7) queue discipline - a priority rule which determines a message's relative position in the queue.
- (8) message delay - the total time that a message spends in the net.
- (9) traffic matrix - the ij entry in this matrix describes the average number of messages generated per second which have node i as an origin and node j as a destination.

1.2 The Quantities of Interest

Having introduced the elementary concepts, we now inquire into those quantities which are of interest in our study of communication nets. We consider these quantities from the viewpoint of the user, the operator, and the designer of the net. Specifically, the user (i. e., the originator and recipient of messages) is concerned with

- (1) the average message delay
- (2) the total traffic handling capability of the net.

The operator (i. e., the one who controls the flow of messages through a node) is concerned with

- (1) the routing procedure
- (2) the priority discipline
- (3) the storage capacity at each node.

The designer of the net is interested in

- (1) the average message delay
- (2) the total traffic handling capability of the net
- (3) the routing procedure
- (4) the priority discipline
- (5) the storage capacity at each node

- (6) the channel capacity of each link
- (7) the topological structure of the net
- (8) the total cost of the system.

As expected, the designer's interest includes and extends beyond those quantities of interest to the user and operator. We choose, therefore, to investigate all of these quantities, as well as certain trading relations which exist among some of them.

1.3 Description of an Existing Store-and-Forward Communication Net

In this section, we describe an existing store-and-forward communication net. In Sect. 1.4, we then abstract a mathematical model to represent systems of this type for purposes of analysis. We choose for this description, an automatic telegraph switching system (Plan 55A [1]*) which has been developed by Western Union for the Air Force in order to handle large quantities of military traffic over a world-wide network. The system was recently installed, and consists of ten switching centers (five domestic and five overseas). These switching centers are interconnected over a network of lines or radio channels which comprise the communicating system for automatic relay of telegraph messages. In addition, each of the main switching centers is connected by lines to a set of tributary stations in the region served by that center. Messages originate at the tributary stations, are transmitted to the regional switching center, and then, perhaps to further switching centers, where, finally, they are transmitted to their destination at other tributary stations.

In the switching centers of this system (i. e. , Western Union's Plan 55A) messages are received and retransmitted in the form of punched (perforated) paper tape. The message's destination is controlled by routing indicators (normally groups of six letters)

* Numerals in square brackets refer to the bibliography.

recorded on the paper tape as part of the message heading. The switching of messages takes place automatically, except at the points of origin and destination. However, it is possible to convert to manual (push button) switching at each center at any time; this mode of operation is abnormal and is used only in case of failure in the automatic switching devices, or in cases of improper format in the received messages.

Certain measures are included in the operation of the net to protect against errors, excessive delays, and lost messages. Each message is numbered as it is transmitted between centers, and these numbers are checked automatically as the message is received. Messages may be transmitted in code or cipher. If so, then either on-line cryptographic equipment is used, in which case decoding takes place each time a message is received, and encoding takes place each time a message is transmitted. If, on the other hand, the coding is done off-line, then the messages are encoded and decoded only at the points of origination and destination. In the latter case, care must be taken to avoid the accidental occurrence of the set of characters which signify the end of the message in the encoded message form.

A strict priority or precedence structure is included in the system, and messages are transmitted in this order of precedence. Six priorities are distinguished in the system, and are detected by inspection of two letters, referred to as precedence prosigns, in the message heading.

In each switching center that it passes through, a message is perforated and transmitted twice. The first reperforation takes place as the message is being received into the switching center. The message is then switched and transmitted across office to a transmitting (or sending) line position, where it is reperforated and transmitted again. The perforated paper tape serves as the store or buffer within the switching center.

The format of a message as it passes through a switching center is shown below.

ZCZCTWA↑204↓ZCBFA↑033↓<<≡RR-RJWFMK<<≡DE-RJEPBF (MESSAGE)<<≡≡≡≡≡≡≡NNNN

start of message sequence number from present center sequence number from last center visited precedence prosign routing indicator originating office end of message

The start of message characters ZCZC and the sequence numbers from the present and last visited center are followed by the precedence prosign and routing indicators, the text of the message itself, and the end of message characters ≡NNNN. The notation used above is: ↑ figure shift; ↓ letter shift; ≡ line feed; — space; < carriage return. Automatic and manual switching are controlled by certain characters which appear in special places in the message. Both the receiving and transmitting positions within the switching center are designed so as to read the routing indicators and precedence prosigns twice, once in order to set up the appropriate control functions, and once for the purpose of transmission (i. e., transmission either across or out of the office). In cross-office transmission, the cross-office line connections are not established until the entire message has been received into the center (i. e., until the end of message symbols are received); the only exception to this rule comes about when emergency messages are received, in which case the connections are set up immediately.

After establishing the cross-office line, a new sequence number is assigned to the message, and the cross-office transmission commences. This transmission proceeds to perforate a second paper tape across the office, and the transmission ceases upon receipt of the end of message characters, thereby disconnecting the cross-office line. The punched paper tape acts, once again, as the storage facility for the message, and the message awaits its turn (on the tape) until the outgoing transmitter reaches it.

From this sending position, the message is either sent to a tributary (and therefore its destination) or to another switching center; in either case, the message format is similar to that described above. Note that only two sequence numbers are associated with the message at any time as it is relayed through the net; that is, each time a new sequence number is introduced, the least recent number is deleted.

When more than one routing indicator is present in a message heading, it is recognized that this is a multiple address message. These messages are processed in a way such that an individual copy of the message reaches each destination. In this case, the routing indicators are separated so that each copy of the message contains only one routing indicator upon reception at each destination. At a switching center, many of the routing indicators may require the same circuit outlet. This occurs, for example, when more than one routing indicator are for tributaries of the same switching center, or for tributaries of different switching centers which may be reached through the same intermediate center. These messages are sent to the intermediate center only with those routing indicators for which that center is responsible.

The incoming cabinet and the outgoing cabinet are the two principal pieces of equipment in a switching center. These cabinets are linked together by cross-office channels (switching circuits) which carry signals at a rate of 200 words per minute (wpm). In addition, a director-translator cabinet is required for automatic switching. The director receives information from the paper tape which allows it to control the switching operations pertinent to the message routing. The translator actually carries out these switch settings. In order to reproduce the incoming message, each receiving position is equipped with a printer-perforator. If, in receiving a message, the end of message characters are missing or altered, then two successive start of message

signals will be detected; in such a case, an alarm is operated, and the operating attendant is called in. In addition to the printer-perforator, each receiving position also has a loop-gate transmitter which reads characters from the punched tape, and transmits them at 200 wpm across the office to a reperforator at the sending position. In order to carry out the automatic cross-office switching, the receiving position obtains a connection and then transmits the precedence prosign and routing indicator(s) to the director via the loop-gate transmitter. In turn, the director relays the required switching information to the receiving position. The transmitter is now ready to transmit across office. The function of the director-translator cabinet may be taken over by the attendant in the manual operation mode. Electronic pulses on a single conductor are used as transmission signals across office (as opposed to the older torn-tape system which required an attendant to tear the tape off the receiving apparatus, carry this tape across the office, and then insert the tape into an appropriate transmitter).

On the sending side of the office, each sending position is equipped with a multi-magnet reperforator which reproduces messages received over cross-office circuits in the form of punched paper tape once again. The reperforator also receives signals from an automatic message numbering machine. The reperforator is designed to perform certain character checking functions which test the operation of all equipment involved in the cross-office transmission. Failure to check activates an alarm condition which alerts an attendant. All sending positions are equipped with a multicontact transmitter distributor which transmits messages from the paper tape to the channel.

For those inter-center channels which carry heavy traffic loads, several inter-connecting line circuits and sending positions are sometimes required. All sending

positions in such a multiple circuit group transmit to identical destinations. Any message for that destination can be switched to any idle circuit within the group.

Messages are received into the center at 60 or 100 wpm; they are then transmitted cross-office at 200 wpm; and finally are retransmitted to outgoing lines at 60 or 100 wpm. Thus, since the cross-office rate is at least twice that of the outgoing lines, a sufficient number of messages can be sent across the office to keep the outgoing lines busy most of the time; consequently, the cross-office transmitters are idle at least half of the time. This being the case, the receiving positions seldom find it necessary to wait for a cross-office connection, and thus no large quantity of backlogged paper tape should form at these positions. In the case of a backlog, the higher cross-office rate should quickly relieve the situation, once a cross-office connection is obtained.

When a receiving position has a message that is to be switched to an outgoing circuit which is busy, the message must wait until a circuit to the desired destination becomes available; if the wait is excessive, or if the message is of extremely high priority, then an alarm is operated which calls an attendant to the position to take suitable action.

In addition to the equipment already described, there is normally provided at each switching center, a traffic control center which simplifies traffic handling and performs certain supervisory functions*. In general, this additional equipment includes a connection indicator board, a traffic routing board, a close-out indicator board, and receiving and sending printer sets. The connection indicator board provides visual means for determining which sending and receiving positions are connected over cross-office lines at any time. Such information is useful for maintenance purposes, as well as

* This equipment is not required, but is often helpful, and aids in the smooth operation of the switching center.

for certain operating conditions; for example, the supervisor can follow a high priority message through the center with the aid of this board, and thus attend to any excessive delays encountered by such a message. The traffic routing board is used for making temporary changes in the routing of messages by means of patching cords which are plugged into the jacks in the routing board. The close-out indicator board provides visual signals for indicating which sending positions are either closed out on the cross-office side, or have their transmitters stopped for any reason.

This completes our description of one existing store-and-forward communication net. Although it does not include in its description all current procedures or equipment, this system does exemplify many message switching nets.

1.4 Assumptions

The description in Sect. 1.3 provides us with an existing store-and-forward communication net from which we may abstract a meaningful, idealized mathematical model. The motivation for using an idealized model is simply that of mathematical ease and tractability; at the same time, however, we must insure that the idealizations introduced lead to a model which retains the essential characteristics of the real system. Specifically, we choose the average message delay as our measure of network performance. Accordingly, we desire that our model, although idealized, exposes the fundamental behavior of the average message delay in store-and-forward nets.

Consider the elementary concepts presented in Sect. 1.1. We offer this description as a starting point for our model, and now proceed to apply certain assumptions to this description. Specifically, the nodes in this description refer to the switching centers, and we consider that the tributary (or originating) stations are part of the

switching center itself. We assume first, that all channels are noiseless, and that all communication centers (nodes) and channels are not subject to damage or destruction (the reliability question). This assumption implies that there are no theoretical or practical problems in transmitting over the channel at a data rate equal to the channel capacity. That is, we may assume that the messages have been encoded into a binary alphabet so that each binary digit corresponds to one bit of data to be transmitted. The encoding required to reduce errors in a noisy channel would introduce additional intra-node delays to the message; we do not consider this case. Furthermore, we assume that cross-office delays are negligible compared to the channel transmission time (a reasonable assumption based upon information on existing and proposed systems).

The study is restricted to data or message traffic, as distinct from telephone or direct wire traffic which has not been considered. We assume that each message has a single destination (as opposed to an all-points message, for example) and that each message must reach that destination before leaving the network (i. e. , no deflections); this involves the additional assumption of an unlimited storage capacity at each node to supply a "waiting room" for those messages in the queue.

In transmitting between two nodes, a message is considered to be received at the second node only after it is fully received. The consequence of this assumption is that messages may not be retransmitted out of a node at the same time that they are being received into the node. Clearly, this represents, at worst, a slightly conservative assumption as regards the message delay in a node. Moreover, many store-and-forward nets do indeed operate in just this manner because of the difference in channel capacity between incoming and cross-office channels.

However, certain data obtained by Molina [2] for telephone traffic corresponds very well to these same assumptions. Moreover, these distributions avoid considerable mathematical complication, and, at the same time, correspond to reasonable (and perhaps conservative) assumptions.

It is appropriate to mention here that many of the results presented in this work include the additional assumption of a constant total channel capacity assigned to the net (i.e., the sum of the capacities of all channels in the net is held fixed).

Finally, we note that one additional assumption is required before we arrive at a mathematically tractable model; we delay discussion of this final assumption until Chap. III.

In summary, we state again, that the worth of this model lies mainly in its retention of the essential character of the message delay in a real store-and-forward communication net.

1.5 Notation and Definitions

As a matter of convenience, we define and list below, some of the important quantities and symbols.

- γ_{jk} = the average number of messages entering the network per second, with origin j and destination k .
- λ_i = the average number of messages entering the i^{th} channel per second.
- $1/\mu_{jk}$ = the average message length, in bits, for messages which have origin j and destination k .
- C_i = the channel capacity of the i^{th} channel.
- γ = the total arrival rate of messages from external sources (see below).

λ = the total arrival rate of messages to channels within the net
(see below).

\bar{n} = the average path length for messages (see below).

$1/\mu$ = the average message length from all sources (see below).

C = the sum of all channel capacities in the net (see below).

ρ = the network load; namely, the ratio of the average arrival rate of bits into the net from external sources to the total capacity of the net (see below).

Z_{jk} = the average message delay for messages with origin j and destination k .

T_i = the average delay to a message in passing through channel i
(this includes both the time on queue and the time in transmission).

T = the average time that messages spend in the network (see below).
This quantity is taken as the measure of performance of a net.

τ = the traffic matrix, whose entries are γ_{jk} .

We collect below certain relations among the definitions above. Some of these relations are by definition, and others may be obtained by simple manipulation.

$$\bar{n} = \lambda/\gamma$$

$$1/\mu = \sum_{j,k} \frac{\gamma_{jk}}{\gamma} \frac{1}{\mu_{jk}}$$

$$\rho = \gamma/\mu C$$

$$C = \sum_i C_i$$

$$\begin{aligned} \gamma &= \sum_{j,k} \gamma_{jk} \\ \lambda &= \sum_i \lambda_i \\ T &= \sum_{j,k} \frac{\gamma_{jk}}{\gamma} z_{jk} = \sum_i \frac{\lambda_i}{\gamma} T_i \end{aligned}$$

1.6 Summary of Results

1.6.1 Analytic Results

The model chosen is described in Sects. 1.1 and 1.4. This model leads to a rather complex mathematical structure. We have, therefore, found it necessary to modify the original model with the introduction of the Independence Assumption. This assumption is carefully discussed in Chap. III; in essence, it assumes that new lengths are chosen for messages (from an exponential distribution) each time they enter a node. As shown in Chap. III, the new model results in a mathematical description which accurately describes the behavior of the message delay in the original model. As a consequence of the Independence Assumption, and of Theorem A.1 (due to Burke), we may analyze each node separately in calculating message delay. We then find ourselves in a position to make some positive statements regarding the quantities of interest as described in Sect. 1.2.

The results obtained from this research for the model described above (including the Independence Assumption) will now be summarized. In considering a single node within the net, one finds that there is a large body of knowledge (namely, classical queueing theory) which deals with such problems. Appendix A describes some of the

well-known results from that theory. Chapter IV describes several new results for single node systems. Specifically, if one considers the problem of determining the number, N , of output channels from a single node in order to minimize the time that a message spends in the node (queueing time plus transmission time), subject to the constraint that each channel is assigned a capacity equal to C/N , one then finds (Theorem 4.2) that $N=1$ is the optimum solution. Further, a new interpretation for the utilization factor* for a single node with multiple output channels is obtained. The obvious trading relations between message delay, channel capacity, and total traffic handled are also developed.

At this point, a result is obtained which has great bearing on the general network problem. The result gives the assignment of channel capacity to a net consisting of N independent nodes (each with a single output channel, see Fig. 4.4) which minimizes the message delay averaged over the set of N nodes, subject to the constraint that the sum of the assigned capacity is constant. Specifically, if λ_i is the average (Poisson) arrival rate of messages to the i^{th} node, and $1/\mu_i$ is the average length of these messages (exponentially distributed), then the optimum assignment, C_i , of the channel capacity to the i^{th} node is

$$C_i = \frac{\lambda_i}{\mu_i} + \left[C - \sum_{i=1}^N \frac{\lambda_i}{\mu_i} \right] \frac{\sqrt{\lambda_i/\mu_i}}{\sum_{j=1}^N \sqrt{\lambda_j/\mu_j}} \quad (1.1)$$

* The utilization factor is merely the ratio of average arrival rate of bits into the node to the total transmission rate of bits out of the node.

where C is the fixed total capacity. The function* which this minimizes is

$$T = \sum_{i=1}^N \frac{\lambda_i}{\lambda} T_i = \frac{\left(\sum_{i=1}^N \sqrt{\frac{\lambda_i}{\lambda \mu_i}} \right)^2}{C(1-\rho)} \quad (1.2)$$

Here, T_i is the average message delay in the i^{th} node, and T is the message delay appropriately averaged over the index i . Theorem 4.4 considers minimizing T (as expressed in Eq. 1.2 above) with respect to the λ_i (assuming $\mu_i = \mu$ for all i), holding λ constant, and subject to the additional constraints that $\lambda_i \geq k_i$ (where we take $k_1 \geq k_2 \geq \dots \geq k_N$ with no loss of generality). The set of numbers k_i represent lower bounds on the traffic flow through each channel, and correspond to one form of physical limitation that may exist. The distribution of λ_i which minimizes T is

$$\lambda_i = \begin{cases} \lambda - \sum_{j=2}^N k_j & i = 1 \\ k_i & i > 1 \end{cases} \quad (1.3)$$

For all $k_i = 0$, all traffic is assigned to (any) one of the channels, and by Eq. 1.1 this channel is allotted the total capacity C . In any case, we observe that this solution displays an attempt to cluster the traffic as much as possible. In fact, the results expressed by Theorem 4.2 and by the trading relations of Sect. 4.3 also indicate the desirability of clustering traffic (and therefore the channel capacity as well) in order to minimize message delay.

* Note that the double subscript, jk , in γ_{jk} may in the case (see Fig. 4.4) be replaced by a single subscript, i ; thus, according to Sect. 1.5, $\lambda_i = \gamma_i$ in this special case, and also $\lambda = \gamma$.

If we now consider the general case of an interconnected net (as, for example, in Fig. 1.1), with N channels indexed by the subscript i , subject to a fixed routing procedure*, then we find that Eq. 1.1 continues to describe the optimum channel capacity assignment. The interpretation of λ_i is still the average arrival rate of messages to the i^{th} channel; for this case, we take $\mu_i = \mu$ for all i . Furthermore, the average message delay, T , under this optimum assignment, becomes

$$T = \frac{\bar{n} \left(\sum_{i=1}^N \sqrt{\lambda_i/\lambda} \right)^2}{\mu C (1 - \bar{n}\rho)} \quad (1.4)$$

where \bar{n} is the average path length for messages in the net. The significance of this equation is discussed below in conjunction with the summary of the simulation experiments.

Constraining the sum of the assigned capacities to be constant implies a special form of system cost. In particular, the implication is that the system cost is represented strictly by the total channel capacity C . A more general cost function may be considered by assigning a function d_i , which represents the cost (in dollars, say) of supplying one unit of capacity to the i^{th} channel**; thus, $d_i C_i$ represents the total cost of assigning the capacity C_i to the i^{th} channel. The optimal channel capacity assignment (namely, that assignment which minimizes T at a fixed cost $D = \sum_{i=1}^N d_i C_i$) has also been derived and is presented in Theorem 4.6. The average message delay, T ,

* By a fixed routing procedure, we mean that given a message's origin and destination, there exists a unique path through the net which this message must follow. If more than one path is allowed, we speak of this as an alternate routing procedure.

**For example, d_i may be taken to be proportional to the length of the i^{th} channel.

which exists for this assignment is also described in Theorem 4.6. Equations 1.1 and 1.2 are seen to be the special case of this theorem in which $d_i = 1$ for all i .

Chapter V explores the manner in which message delay is affected when one imposes a priority structure on the set of messages. Generally, one breaks the message set into P separate groups, the p^{th} group ($p=1, 2, \dots, P$) being given preferential treatment over the $p-1^{\text{st}}$ group, etc. A newly derived result for a delay dependent priority system is described, in which a message's priority is increased, from zero, linearly with time in proportion to a rate assigned to the message's priority group. The usefulness of this priority structure is that it provides a number of degrees of freedom with which to manipulate the relative waiting times for each priority group.

An interesting new law of conservation is also proven which constrains the allowed variation in the average waiting times for any one of a wide class of priority structures. Specifically, if we denote by W_p the average time that a message from the p^{th} priority group spends in the queue, then the conservation law states that

$$\sum_{p=1}^P (\lambda_p / \mu_p) W_p = \text{constant with respect to variation of the priority structure.}$$

where λ_p and $1/\mu_p$ are, respectively, the average arrival rate and average message length for messages from the p^{th} priority group. The analytic expression for this constant is evaluated in Chap. V. As a result of this law, a number of general statements can be made regarding the average waiting times for any priority structure

which falls in this class*. A priority structure which results in a system of time-shared service is also investigated. This system presents shorter waiting times for "short" messages and longer waiting times for "long" messages; interestingly enough, the critical message length which distinguishes "short" from "long" turns out to be the average message length for the case of geometrically distributed message lengths.

Random routing procedures for some specialized nets yield to mathematical analysis, and are discussed in Chap. VI. Specifically, a random routing procedure is a routing procedure in which the choice for the next node to be visited is made according to some probability distribution over the set of neighboring nodes. The first result obtained therein is the expected number of steps that a message must take (in a net which carries no other traffic) before arriving at its destination for that class of random routing procedures in which the node to node transitions are describable by circulant** transition matrices. This result exposes the increased number of steps that a message must take in a net with random routing. The next quantity of interest is the expected time that a message spends in the net. The solution for this is presented in Theorem 6.3 (which, once again, makes use of the Independence Assumption). A quantitative comparison is made for identical nets between random and fixed routing procedures, demonstrating the superiority of the latter as regards message delay.

The last phase of the research describes the results of a large scale digital simulation of store-and-forward communication nets. The simulation program (written for Lincoln Laboratory's TX-2 computer) is described in Appendix E. Extensive use

* See Chap. V for an exact description of the class.

** A circulant matrix is one in which each row of that matrix is a unit rotation of the row above it (see Eq. 6.2).

was made of the simulator in confirming and extending many of the results of this research. For example, it provided a powerful tool for testing the accuracy and suitability of the Independence Assumption. Furthermore, networks of identical topological structure to those described in Chap. VI (Random Routing Procedures) were simulated with fixed routing procedures, and, as predicted, the comparative results indicate that random routing procedures are costly in terms of total traffic handled and message delay. A priority discipline was imposed on the message traffic in some of the runs, and these results indicate that the conservation law of Chap. V holds for nets as well as for a single node.

1.6.2 Experimental Results

With the background of theoretical results obtained in the material described above, a careful experimental investigation was carried out (using the network simulation program) for the purpose of examining the variation of average message delay for different channel capacity assignments, routing procedures, and topologies. These results are presented in Chap. VII*. Specifically, it was found that the channel capacity assignment expressed in Eq. 1.1 (to be referred to as the square root channel capacity assignment) was superior to all other assignments tested, not only for fixed routing procedures (as predicted), but also for a class of alternate routing procedures. Further, it was observed that with the square root capacity assignment, fixed routing was always superior to alternate routing for the same traffic and the same net. This result is not surprising when one recognizes that alternate routing procedures are designed to disperse the traffic whenever and wherever it is reasonable to do so**. This is in direct

* The simulation experiments described in this chapter were performed without the use of the Independence Assumption.

**In addition, alternate routing procedures, in general, result in an increased average path length (\bar{n}).

opposition to the result expressed by Eq. 1.3 in which it is clear that clustered traffic is to be preferred. However, the simulation results exposed the ability of alternate routing procedures to adapt the traffic flow so as to fit the network topology; specifically, it was observed that under a poor channel capacity assignment (in violation of Eq. 1.1), the performance of alternate routing was superior to fixed routing. This adaptive behavior of alternate routing procedures has considerable significance in the realistic design and operation of a communication net. Specifically, it is generally true that the actual traffic matrix is not known precisely at the time the network is being designed. Indeed, even if the traffic matrix were known, it is probable that the entries, γ_{jk} , in this matrix would be time-varying (i.e., different traffic loads exist at different hours of the day, different days of the week, different seasons of the year, etc.). In the face of either this uncertainty or variation, or both, it becomes impossible to calculate the optimum channel capacity assignment from Eq. 1.1 since the numbers λ_i (which are calculable from the γ_{jk} under a fixed routing procedure) are in doubt. One solution to this problem is to use some form of alternate routing which will then adapt the actual traffic flow to the network. Note, however, that a price must be paid for such flexibility, since fixed routing with the square root capacity assignment is itself superior to alternate routing (assuming we have known time-invariant γ_{jk}).

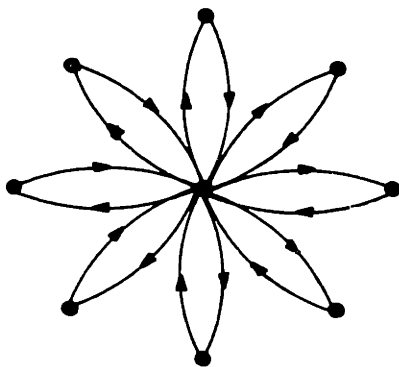

Figure 1.2 The star net configuration

The desirability of a clustered traffic pattern led to consideration of a special topology, namely, the star net, as shown in Fig. 1.2. This net has the property that as much traffic as possible is grouped into each channel; the physical constraint here is that the set of origins and destinations (i. e. , the traffic matrix) is specified independent of the network design, and, so, one is forced to have at least one channel leading to and from each node in the net. The star net yields exactly one channel leading in and out of each node (except, of course, for the central node). The effect of the distribution of traffic (λ_i) and the average path length (\bar{n}) on the average message delay in a net with a fixed routing procedure may be seen in Eq. 1.4. In particular, we note that increased clustering of traffic reduces the expression $\sum_{i=1}^N \sqrt{\lambda_i/\lambda}$, e. g., see Eq. 1.3. Furthermore, we note that T grows without bound as $\rho \rightarrow 1/\bar{n}$; recall that $\rho = \gamma/\mu C$ is the ratio of average arrival rate of bits into the net from external sources to the total capacity of the net. Clearly, a minimum value of \bar{n} is desired. However, it is obvious that the adjustment of λ_i alters the value of \bar{n} . In particular, for the star net (which has a maximally clustered traffic pattern) we observe that $1 < \bar{n} < 2$. If we require a reduced \bar{n} , we must add channels to the star net, thus destroying some of the clustering of traffic. In the limit as $\bar{n} \rightarrow 1$, we arrive at the fully connected net which has the

smallest possible \bar{n} , but also the most dispersed traffic pattern. The trade-off between \bar{n} and traffic clustering depends heavily upon ρ . In particular, we find that at low network load nets similar to the topology of the star net are optimum; as the network load increases, we obtain the optimum topology by reducing \bar{n} (by adding additional channels); and, finally, as $\rho \rightarrow 1$, we require $\bar{n} = 1$ which results in the fully connected net. In all cases, we use the square root channel capacity assignment with a fixed routing procedure.

A number of interesting results obtained with the help of simulation experiments have been described. These results pertain to the behavior of the average message delay (taken as the measure of performance of the net) as the following three design parameters are varied; channel capacity assignment; routing procedure; and topological structure. Specifically, the problem solved is the minimization of the average message delay at a fixed cost (i. e., at fixed total channel capacity). We now summarize the results of Chap. VII.

- (1) The square root channel capacity assignment as described in Eq. 1.1 results in superior performance as compared to a number of other channel capacity assignments.
- (2) The performance of a straightforward fixed routing procedure, with a square root capacity assignment, surpasses that of a simple alternate routing procedure.
- (3) The alternate routing procedure adapts the internal traffic flow to suit the capacity assignment (i. e., the bulk of the message traffic is routed to the high capacity channels). This effect is especially

noticeable and important in the case of a poor capacity assignment which may come about due to uncertainty or variation in the applied message traffic.

- (4) A high degree of non-uniformity in the traffic matrix results in improved performance for the case of a square root channel capacity assignment (due to a more clustered traffic pattern).
- (5) The quantities essential to the determination of the average message delay are the average path length and the degree to which the traffic flow is clustered. The trade-off between these two quantities allows one to determine the sequence of optimal network topologies which ranges from the star net at small values of network load to the fully connected net as the network load approaches unity.

CHAPTER II

HISTORY OF THE PROBLEM

The application of probability theory to problems of telephone traffic represents one of the earliest areas of investigation related to the present communication network problem. The first effort in this direction dates back to 1907 and 1908 when E. Johannsen* [3] published two papers concerned with the delays and busy signals which subscribers experienced in placing telephone calls. It was he who influenced A. K. Erlang** to investigate other problems of this sort. Erlang's works are reported (in English) in [3], and represent a number of major contributions to telephone traffic theory. His most significant work appeared in 1917, in which he considered the utilization of equipment in the telephone exchange under a fluctuating demand for service.

Other workers made contributions in this direction at that time, and O'Dell [4, 5] gives an account of the theories up to 1920; his principal work on grading appeared in 1927. E. C. Molina [2, 6] also made some noteworthy contributions during that era.

The theory of stochastic processes was developed after Erlang's work. However, Erlang first considered the notion of statistical equilibrium (and discussed the distributions of holding times and incoming calls) for application to problems of telephone traffic. Much of modern queueing theory deals with the development of these basic ideas by means of more recent mathematical tools.

In 1928, T. C. Fry [7] published his book (which has since become a classic work) in which he offered a fine survey of congestion problems. He was the first to present a

* Reference to Johannsen's work will be found in [3, p. 14].

** Erlang was an engineer with the Copenhagen Telephone Exchange.

unified approach to the results up to that time. Another writer of that period was C. Palm [8,9], who was the first to use generating functions in studying the formulas of Erlang and O'Dell. His works appeared in 1937-1938. During this time, a large number of specific applications (mostly lost call problems) were investigated, using the theories already developed. Fry and Palm both developed the equations (now recognized as the Birth and Death equations) which provide the basis for many results in queueing theory.

In 1939, Feller [10] introduced the concept of the Birth and Death process, and ushered in modern queueing theory. His application was in physics and biology, but it was clear that the same process characterized a number of models useful in telephone traffic problems. Many applications of these equations were made by Palm [11] in 1943. In 1948, Jensen (see [3]) also used this process for the elucidation of Erlang's work. Kosten [12], in 1949, studied the probability of loss by means of generalized Birth and Death equations. Waiting line and trunking problems were discussed by Feller [13] in his widely used book on probability, making use of the theory of stochastic processes.

In 1950, C. E. Shannon [14] considered the problem of storage requirements in telephone exchanges, and concluded that a bound can be placed on the size of such storage, by estimating the amount of information used in making the required connections. In 1951, F. W. Riordan [15] investigated a new method of approach suitable for general stochastic processes. R. Syski [16], in 1960, published a fine book in which he presented a summary of the theory of congestion and stochastic processes in telephone systems, and also cast some of the more advanced mathematical descriptions in common engineering terms. In 1961, T. L. Saaty [17] published a comprehensive book on the

subject of queues. In 1962, J. Riordan [18] published a text in which he dealt with some combined problems in queueing theory and traffic probability theory.

In the early 1950's, it became obvious that many of the results obtained in the field of telephony were applicable in more general situations; thus started investigations into waiting lines of many kinds, which has developed into modern queueing theory (a theory which finds numerous applications in the field of operations research). A great deal of effort has been spent on single node facilities, i. e. , a system in which "customers" enter, join a queue, eventually obtain "service" and upon completion of this service, leave the system. P. M. Morse [19] presents a fine introduction to such facilities in which he defines terms, indicates applications, and outlines some of the analytic aspects of the theory. P. Burke [20], in 1956, showed that for independent inter-arrival times (i. e. , Poisson arrival), and exponential distribution of service times, the inter-departure times would also be independent (Poisson). In 1959, F. Foster [21] presented a duality principle in which he shows that reversing the roles of input (arrivals) and output (service completions) for a system will define a dual system very much like the original system. In contrast to the abundant supply of papers on single node facilities, relatively few works have been published on multi-node facilities (which is the area of interest to this thesis). Among those papers which have been presented is one by G. C. Hunt [22] in which he considers sequential arrays of waiting lines. He presents a table which gives the maximum utilization factor (ratio of average arrival rate to maximum service rate) for which steady state probabilities of queue length exist, under various allowable queue lengths between sequential service facilities. J. R. Jackson [23], in 1957, published a paper in which he investigated networks of waiting lines. His network consisted of a number of service facilities into which customers entered both from external

sources as well as after having completed service in another facility. He proves a theorem which, stated roughly, says that a steady state distribution for the system state exists, as long as the effective utilization factor for each facility is less than one, and, in fact, this distribution takes on a form similar to the solution for the single node case. In 1960, R. Prosser [24] offered an approximate analysis of a random routing procedure in a communication net in which he shows that such procedures are highly inefficient but extremely stable (i. e. , they degrade gracefully under partial failure of the network). Furthermore, Prosser [25] describes an approximate analysis of certain directory procedures in which he concludes that the disadvantages of such procedures are the necessity of maintaining the directories, and the need to determine optimal paths from the directory information; he also concludes that the advantages (as compared to random routing procedures) are the increase in efficiency and in the capacity of operation.

The important characteristic of the communication nets that form the subject of this thesis is that each node is capable of storing messages while they wait for transmission channels to become available. As has been pointed out, queueing theory has directed most of its effort so far toward single node facilities with storage. There has been, in addition, a considerable investigation into multi-node nets, with no storage capabilities, mainly under the title of Linear Programming (which is really a study of linear inequalities and convex sets). This latter research considers, in effect, steady state flow in large connected nets, and has yielded some interesting results. One problem which has attracted a lot of attention is the shortest route problem; M. Pollack and W. Wiebenson [26] present a review of the many solutions to this problem, among which are Dantzig's simplex method, Minty's labelling method, and the Moore-D'Esopo

method. W. Jewell [27] has also considered this problem in some greater generality, and, by using the structure of the network and the principle of flow conservation, has extended an algorithm due to Ford and Fulkerson in order to solve a varied group of flow problems. R. Chien [28] has given a systematic method for the realization of minimum capacity communication nets from their required terminal capacity requirements (again considering only nets with no storage capabilities); a different solution to the same problem has been obtained by Gomory and Hu [29] in which they solved for the minimum capacity net which could handle all traffic requirements between a pair of nodes individually. In general, these linear programming solutions take the form of algorithms with vast computational requirements. In 1956, P. Elias, A Feinstein, and C. E. Shannon [30] showed that the maximum rate of flow through a network, between any two terminals, is the minimum value among all simple cut-sets. Also, in 1956, Z. Prihar [31] presented an article in which he explored the topological properties of communication nets; for example, he showed matrix methods for finding the number of ways to travel between two nodes in a specific number of steps.

The problems handled by the techniques of linear programming have a great deal in common with the communication problem at hand. Their problem is that of solving networks in which the commodity (e. g. , water, people, information) flows steadily. A typical problem is that of finding the set of solutions (commonly referred to as feasible solutions) which support a given traffic flow in a network. A solution consists of specifying the flow capacity for each link between all pairs of nodes. In general, a large number of solutions exist, and a lot of effort has been spent in finding that solution which minimizes the total capacity used. One obvious requirement is that the average traffic entering any node must be less than the total capacity leaving the node. Notice that the

important statistic here is the average traffic flow, and if the flow is steady, then we have a deterministic problem. Now, in what way does this problem differ from the problem considered in this thesis? Clearly, the difference is that we do not have a steady flow of traffic; rather, our traffic comes in spurts, according to some probability distribution. Consequently, we must be prepared to waste some of our channel capacity, i. e., the channel will sometimes be idle*.

In 1959, P. A. P. Moran [32] wrote a monograph on the theory of storage. The book describes the basic probability problems that arise in the theory of storage, paying particular attention to problems of inventory, queueing, and dam storage. It represents one of the few works pertaining to a system of storage facilities.

The results from information theory [33] also have relation to the communication net problem considered here. Most of the work there has dealt with communication between two points, rather than communication within a network. In particular, one of the major results says that there is a trade-off between message constraint length and probability of error in the transmitted message for noisy transmission channels. Thus, if delays are of no consequence, transmission with an arbitrarily low probability of error can be achieved. The effect of this constraint length is to add additional intra-node delays to the message. We will not deal specifically with noisy channels, although such an avenue of investigation represents an interesting extension for future study.

* For a more detailed discussion of this difference, the reader is referred to the introductory paragraphs in Appendix A.

CHAPTER III
 THE PROBLEMS OF AN EXACT MATHEMATICAL SOLUTION
 TO THE GENERAL COMMUNICATION NET

3.1 Discussion of the General Problem

We have before us the task of supplying answers to the various questions posed by the designer in Sect. 1.2. Therefore, we require a mathematical description of the behavior of the message delay as we vary the design parameters*. One way in which such a description can be obtained is by consideration of an appropriate set of state variables. Specifically, this set of variables must satisfy two conditions. First, the set must include (explicitly or implicitly) those quantities which are of interest, e.g., the message delay. Second, the set must be a complete, or closed, set, such that knowledge of the state variables at time t and knowledge of all message arrivals from sources external to the net in the closed interval (t, t') is sufficient to uniquely specify the state variables at time $t' \geq t$. This second condition describes the Markovian property.

One set of state variables which satisfies these conditions will now be defined. We consider a communication net with N nodes and M one-way channels, under the same assumptions as are described in Sect. 1.4. It is clear that the state of the net at any instant of time must include the detailed information as to the number of messages on each queue, the length of each message, and the time required to complete the transmission in progress on each channel. Furthermore, we assume that each message is labelled with an origin, a destination, and a priority. Accordingly, we define

* The design parameters under consideration are: capacity assignment to each channel; topological structure; routing procedure; priority discipline; total traffic handled; and total system cost.

C_i	= capacity, in bits/sec. of the i^{th} channel
n_i	= number of messages waiting for (or being transmitted on) the i^{th} channel
γ_i	= average arrival rate of messages, from external sources, to the i^{th} channel
$v_{in}^{(x_{in}, y_{in}, z_{in})}$	= message length*, in bits, of the n_i^{th} message waiting for (or being transmitted on) the i^{th} channel, whose origin, destination, and priority are x_{in}, y_{in}, z_{in} , respectively. For conciseness of notation, we let the symbol v_{in} denote this length.
V_{n_i}	= the set of numbers $(v_{i1}, v_{i2}, \dots, v_{in_i})$
r_i	= the time remaining to complete the transmission in progress on the i^{th} channel
R	= the set of numbers (r_1, r_2, \dots, r_M)
$R+dt$	= the set of numbers $(r_1+dt, r_2+dt, \dots, r_M+dt)$

where

$$i = 1, 2, \dots, M$$

and

$$n = 1, 2, \dots, n_i$$

The state of the net at any time t , may be completely described by the set of variables

$$S = (n_1, n_2, \dots, n_M, V_{n_1}, V_{n_2}, \dots, V_{n_M}, R)$$

Clearly, all of these quantities are functions of time. The dimensionality of this state description is unbounded since the variables n_i are unbounded. Furthermore, all of these variables are necessary in order to complete the state description.

* Recall that the distribution of message lengths is exponential, with the mean length $1/\mu$.

Associated with each state S , and each time t , is a probability density function $p_t(S)$ that the net will be found in state S at time t . In general, one desires the explicit solution for the function $p_t(S)$. To date, this problem remains unsolved. However, we will carry out a portion of the analysis in an effort to indicate the source of the difficulty. In particular, let us set up the equations under the conditions

$$n_i > 1$$

$$0 < r_i < v_{i1}/C_i$$

The first condition, $n_i > 1$, is included for convenience at this point. The end points 0 and v_{i1}/C_i are excluded from the allowed range of r_i in order to temporarily eliminate from discussion any consideration of internal message arrivals*. For this case, we write down immediately that

$$p_{t+dt}(n_1, n_2, \dots, n_M, V_{n_1}, V_{n_2}, \dots, V_{n_M}, R) =$$

$$p_t(n_1, n_2, \dots, n_M, V_{n_1}, V_{n_2}, \dots, V_{n_M}, R+dt) \left(1 - \sum_{i=1}^M \gamma_i dt\right)$$

$$+ \sum_{i=1}^M \gamma_i' dt \mu e^{-\mu v_{in_i}} p_t(n_1, n_2, \dots, n_i-1, \dots, n_M, V_{n_1}, V_{n_2}, \dots, V_{n_i-1}, \dots, V_{n_M}, R+dt)$$

where γ_i' represents that portion of γ_i which has the appropriate x_{in_i} , y_{in_i} , and z_{in_i} which correspond with v_{in_i} . This leads us to the following partial differential difference equation

* An internal message arrival occurs when a message completes its transmission between two nodes internal to the net (as opposed to an external message arrival which occurs when a message arrives at its origin from a source external to the net).

$$\begin{aligned}
& \frac{\partial p_t}{\partial t} (n_1, n_2, \dots, n_M, V_{n_1}, V_{n_2}, \dots, V_{n_M}, R) \\
& - \sum_{i=1}^M \frac{\partial p_t}{\partial r_i} (n_1, n_2, \dots, n_M, V_{n_1}, V_{n_2}, \dots, V_{n_M}, R) = \\
& \sum_{i=1}^M \gamma_i \mu e^{-\mu v_i n_i} p_t (n_1, n_2, \dots, n_i-1, \dots, n_M, V_{n_1}, V_{n_2}, \dots, V_{n_i-1}, \dots, V_{n_M}, R) \\
& - p_t (n_1, n_2, \dots, n_M, V_{n_1}, V_{n_2}, \dots, V_{n_M}, R) \sum_{i=1}^M \gamma_i
\end{aligned}$$

where $n_i > 1$ and $0 < r_i < v_{i1}/C_i$. The equations involving r_i at its end points force one to consider internal message arrivals and become considerably more complex. In particular, one must then include the rules of the routing procedure in determining which transitions occur. The task of solving this set of partial differential difference equations is formidable, and no solution has yet been found.

The complexity of the state description is due in part to the constraint that each message, upon entering the net, has a permanent length assigned to it. The message maintains this same length as it travels through the net. This clearly necessitates the inclusion of the variables V_{n_i} in the state description. The identification of a permanent length with each message not only increases the dimensionality of the state description, but also complicates the stochastic behavior of the net by introducing a dependence among some of the random variables which describe the net. In particular, if we consider two successive messages arriving at node i from some other node internal to the net, then the inter-arrival time between these messages is not independent

of the message length of the second of the two messages*. More specifically, let us derive the joint probability density function $p(v_n, a_{2n})$ for the simple two node tandem net shown in Fig. 3.1, where we define

v_n = message length of the n^{th} message (in bits)

a_{in} = time between the arrival of the $(n-1)^{\text{st}}$ and n^{th} messages to node i .

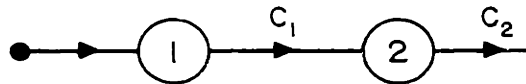

Figure 3.1 A two node tandem net.

For convenience, we take $C_1=1$ bit/sec. Clearly this represents no loss of generality.

By the assumptions of Sect. 1.4, we recall that both a_{1n} and v_n are described by the following exponential probability density functions

$$\begin{aligned} p(a_{1n}) &= \gamma e^{-\gamma a_{1n}} \\ p(v_n) &= \mu e^{-\mu v_n} \end{aligned} \quad (3.1)$$

Further, for our immediate purposes, it is convenient to assume that all messages originate at node 1 and are required to pass through nodes 1 and 2.

* Of course, this independence exists for messages which arrive from an external source by assumption.

Observe that channel C_1 fits the classical queueing theory model of a single exponential channel system as described in Appendix A; hence, all results from that appendix apply. Since Theorem A.1 (due to Burke) holds, and since the inter-departure times for messages leaving node 1 are, by definition, identical to the inter-arrival times for messages entering node 2, we see that

$$p(a_{2n}) = \gamma e^{-\gamma a_{2n}} \quad (3.2)$$

The n^{th} message leaving node 1 is either (1) separated by a time gap, g_n , from the $(n-1)^{\text{st}}$ message, or (2) transmitted immediately after the $(n-1)^{\text{st}}$ message is finished (see Fig. 3.2). Case 1 occurs only if the first node emptied while

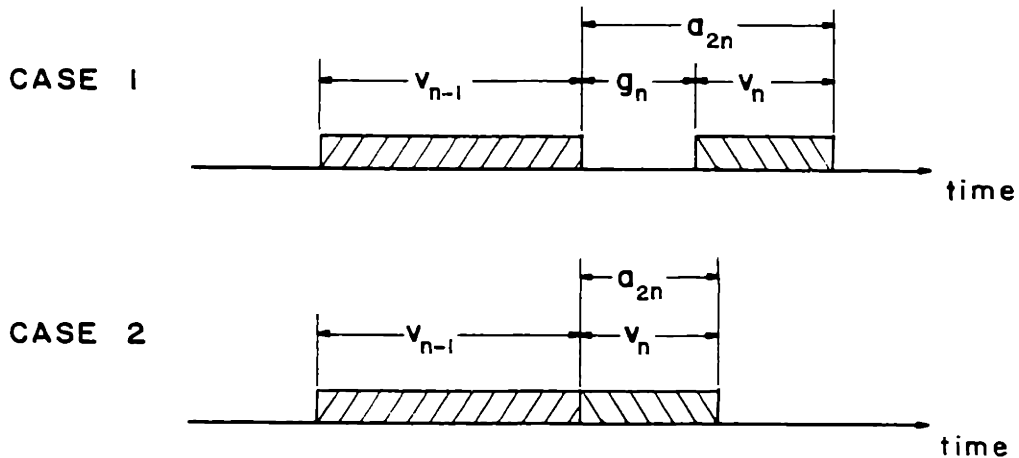

Figure 3.2 Adjacent messages leaving node 1.

awaiting the n^{th} message, and this occurs with probability $1-\rho$ (see Eq. A.3 in Appendix A) where $\rho = \frac{\gamma}{\mu C_1} = \frac{\gamma}{\mu}$; and case 2 occurs if the first node is busy when the n^{th} messages arrives, which has probability ρ . Thus

$$p(v_n, a_{2n}) = \rho P_r [v_n, a_{2n} \mid \text{node 1 busy}] + (1-\rho) P_r [v_n, a_{2n} \mid \text{node 1 empty}] \quad (3.3)$$

Clearly*,

$$P_r [v_n, a_{2n} \mid \text{node 1 busy}] = P_r [v_n = a_{2n}] = \mu e^{-\mu v_n} u_0(a_{2n} - v_n)$$

and also,

$$\begin{aligned} P_r [v_n, a_{2n} \mid \text{node 1 empty}] &= P_r [a_{2n} \mid v_n, \text{node 1 empty}] P_r [v_n \mid \text{node 1 empty}] \\ &= P_r [g_n = a_{2n} - v_n] P_r [v_n \mid \text{node 1 empty}] \end{aligned}$$

Due to the memoryless property of an exponential distribution (see the discussion on page 195), g_n is also distributed according to Eq. 3.2. Thus

$$P_r [v_n, a_{2n} \mid \text{node 1 empty}] = \gamma e^{-\gamma(a_{2n} - v_n)} \mu e^{-\mu v_n}$$

Therefore, Eq. 3.3 becomes

$$p(v_n, a_{2n}) = \gamma e^{-\mu v_n} u_0(a_{2n} - v_n) + \gamma(\mu - \gamma) e^{-\gamma(a_{2n} - v_n) - \mu v_n} \quad (3.4)$$

This last equation gives the desired joint probability density function of v_n and a_{2n} .

Upon comparing Eqs. 3.1, 3.2, and 3.4, we see that

$$p(v_n, a_{2n}) \neq p(v_n) p(a_{2n})$$

which, by definition, illustrates a lack of independence between v_n and a_{2n} . This lack of independence is the source of great complication in the exact mathematical analysis of the general net; indeed, no general solution has been obtained.

* $u_0(x)$ is the unit impulse function

3.2 The Tandem Net

If we consider the tandem net as shown in Fig. 3.3, we simplify the general problem somewhat*. In particular, we remove from consideration, the question of

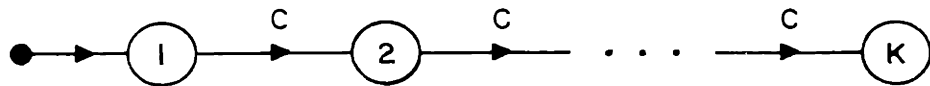

Figure 3.3 The tandem net with K nodes.

origin, destination and routing procedure since all messages originate at node 1, are destined for node K , and are routed successively through nodes $1, 2, 3, \dots, K$. We do, however, retain the dependency between the inter-arrival time and lengths of messages. In addition, since we have only one external input (at node 1), the complete course of a message can be calculated deterministically as soon as that message arrives at node 1. That is, we can state exactly how long that message will spend in each node k ($k=1, 2, \dots, K$). Nevertheless, the complete mathematical solution for this simplified net evades us. We have been able to obtain some partial results which we now proceed to describe.

Both v_n and a_{in} retain their definitions from Sect. 3.1. We introduce the additional notation for w_{kn} and g_{kn} as follows.

*Note that $C_k = C$ for $k=1, 2, \dots, K$. We take $C=1$ for convenience.

w_{kn} = total time that the n^{th} message spends in node k

g_{kn} = time that the k^{th} node remains idle while awaiting the arrival of the n^{th} message.

In Fig. 3.4, we show graphically, the history of 7 messages as they pass through the first 3 tandem nodes. The function plotted is the total unfinished work, $U_k(t)$, in

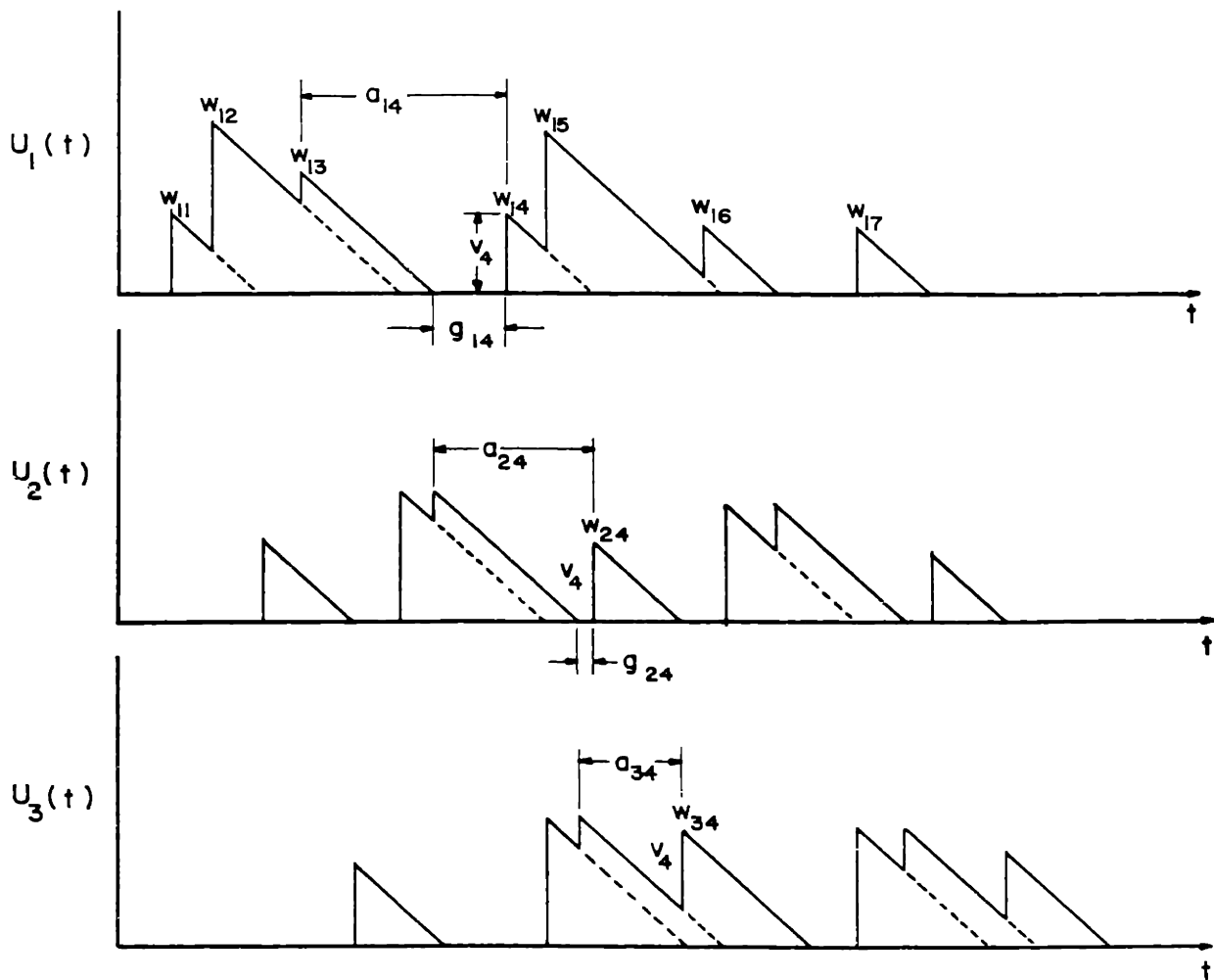

Figure 3.4 Example of $U_k(t)$ for the first three tandem nodes.

the k^{th} node; it represents the total number of seconds that will elapse before the k^{th} node empties, if no other messages enter this node after time t . For purposes of illustration, the fourth message is the only one labelled in the second and third nodes.

It is clear that if the n^{th} message arrives at node k at time t , then it adds v_n to $U_k(t^-)$. That is*,

$$U_k(t^+) = U_k(t^-) + v_n \quad (3.5)$$

But,

$$w_{kn} = U_k(t^+)$$

Now, if $g_{kn} > 0$, which means that the k^{th} node was idle at time t^- , then $U_k(t^-) = 0$, and so

$$w_{kn} = v_n \quad \text{for } g_{kn} > 0$$

If, on the other hand, $g_{kn} = 0$, then $U_k(t^-)$ was still positive and decreasing at a rate of 1 sec/sec; in fact, since exactly a_{kn} seconds had elapsed since the $(n-1)^{\text{st}}$ message arrived,

$$U_k(t^-) = w_{k, n-1} - a_{kn}$$

and so, from Eq. 3.5, we obtain

$$w_{kn} = w_{k, n-1} - a_{kn} + v_n \quad \text{for } g_{kn} = 0 \quad (3.6)$$

Note that for $k \geq 2$, the inter-arrival time a_{kn} is made up of the transmission time out of the $(k-1)^{\text{st}}$ node for the n^{th} message, plus any time that the $(k-1)^{\text{st}}$ node spent idle awaiting the arrival of the n^{th} message. That is,

$$a_{kn} = v_n + g_{k-1, n} \quad (3.7)$$

* t^- is defined as $t-dt$, and t^+ as $t+dt$.

Therefore, Eq. 3.6 may be written as

$$w_{kn} = w_{k,n-1} - g_{k-1,n} \quad \text{for } g_{kn} = 0 \text{ and } k \geq 2$$

Furthermore, it is clear that the maximum that the k^{th} node can reduce its unfinished work in the time between the arrival of the $(n-1)^{\text{st}}$ and n^{th} messages, is a_{kn} . Thus, if $a_{kn} \leq w_{k,n-1}$, then the idle time, g_{kn} , in node k before the n^{th} arrival will be zero. If $a_{kn} \geq w_{k,n-1}$, then $g_{kn} = a_{kn} - w_{k,n-1}$. Summarizing the results for the tandem net so far, we have,

$$w_{1n} = \begin{cases} w_{1,n-1} - a_{1n} + v_n & \text{for } g_{1n} = 0 \\ v_n & \text{for } g_{1n} > 0 \end{cases} \quad (3.8)$$

$$w_{kn} = \begin{cases} w_{k,n-1} - g_{k-1,n} & \text{for } g_{kn} = 0, k \geq 2 \\ v_n & \text{for } g_{kn} > 0, k \geq 2 \end{cases} \quad (3.9)$$

$$g_{kn} = \begin{cases} 0 & \text{for } a_{kn} \leq w_{k,n-1} \\ a_{kn} - w_{k,n-1} & \text{for } a_{kn} \geq w_{k,n-1} \end{cases} \quad (3.10)$$

We now proceed to derive an expression for $P_r [w_{kn} \leq W]$, for $k \geq 2$. From Eqs. 3.9 and 3.10 we immediately obtain

$$\begin{aligned} P_r [w_{kn} \leq W] &= P_r [w_{k,n-1} - g_{k-1,n} \leq W, a_{kn} \leq w_{k,n-1}] \\ &\quad + P_r [v_n \leq W, a_{kn} \geq w_{k,n-1}] \end{aligned}$$

By use of Eq. 3.7, we obtain

$$\begin{aligned} P_r [w_{kn} \leq W] &= P_r [v_n \leq w_{k,n-1} - g_{k-1,n} \leq W] \\ &+ P_r [w_{k,n-1} - g_{k-1,n} < v_n \leq W] \end{aligned}$$

Defining $x_{kn} = w_{k,n-1} - g_{k-1,n}$ we observe that the above equation integrates the probability over the region in the product space of x_{kn} and v_n such that $x_{kn} \leq W$ and also $v_n \leq W$. Thus, we finally obtain

$$P_r [w_{kn} \leq W] = P_r [v_n \leq W, w_{k,n-1} \leq W + g_{k-1,n}] \quad (3.11)$$

This is an interesting and general result for the tandem net, with $k \geq 2$.

Let us now consider a very special situation wherein each node remains idle for a fixed time, g , after it completes the transmission of each message. This assumption is made in order to break the dependency of v_n and $g_{k-1,n}$. With this assumption, we find that

$$P_n(W) = V_n(W) P_{n-1}(W+g) \quad (3.12)$$

where

$$P_n(W) = P_r [w_{kn} \leq W]$$

and

$$V_n(W) = P_r [v_n \leq W]$$

For $\gamma/\mu < 1$, the steady state exists, and we have

$$P(W) = \lim_{n \rightarrow \infty} P_n(W)$$

Thus, Eq. 3.12 becomes, in the limit,

$$P(W) = V(W) P(W+g) \quad (3.13)$$

From Eq. 3.13, we may write

$$P(W+g) = V(W+g) P(W+2g)$$

and so on. Now, since $P(W)$ is a cumulative distribution function, we know that

$$\lim_{m \rightarrow \infty} P(W+mg) = 1$$

and so Eq. 3.13 may be written as

$$P(W) = \prod_{m=0}^{\infty} V(W+mg)$$

Thus, since we have exponentially distributed message lengths, with a fixed idle time g , we obtain

$$P(W) = \lim_{n \rightarrow \infty} P_r [w_{kn} \leq W] = \prod_{m=0}^{\infty} \left(1 - e^{-\mu(W+mg)} \right)$$

From this last equation, we note that as $g \rightarrow 0$, which corresponds to the case $\gamma/\mu \rightarrow 1$, the message delays grow without bound as $n \rightarrow \infty$; this means that $\gamma/\mu = 1$ must be a pole for the message delay in all nodes.

Returning now to the case in which we remove the restriction of a fixed idle gap for each node (i.e., g_{kn} now obeys Eq. 3.10 once again), we consider the limiting behavior of the message traffic leaving the K^{th} node as $K \rightarrow \infty$. We introduce the notion of a busy period for the k^{th} node as being an interval of time during which the k^{th} node is continuously transmitting messages. We will also refer to the m^{th} busy period for node k as the m^{th} occurrence of a busy period for that node. Define

L_{mk} as the length (in bits or seconds since $C=1$) of the message which initiates the m^{th} busy period in node k .

T_{mk} as the time between the start of the m^{th} and $(m-1)^{\text{st}}$ busy periods in node k .

$$L_m = \lim_{K \rightarrow \infty} L_{mK}$$

$$T_m = \lim_{K \rightarrow \infty} T_{mK}$$

$$p(i | L_m) = \lim_{K \rightarrow \infty} P_r \{ i \text{ messages in the } m^{\text{th}} \text{ busy period of the } K^{\text{th}} \text{ node, given } L_{mK} \}$$

$$p'(L | L_m) = \lim_{K \rightarrow \infty} P_r \{ L \text{ given } L_{mK}, \text{ where } L + L_{mK} \text{ is the total length of the } m^{\text{th}} \text{ busy period in node } K \}$$

With these definitions, we now state

THEOREM 3.1

As $K \rightarrow \infty$, the limiting form of the message traffic as it leaves the K^{th} node behaves as follows;

(1) All messages in the m^{th} busy period spend exactly L_m seconds in the K^{th} node, where $L_m = L_{m2}$.

(2) $L_m \geq L_{m-1} \quad m=1, 2, 3, \dots$

(3)
$$T_m = \begin{cases} T_{m1} & \text{if } L_m = L_{m-1} \\ \infty & \text{if } L_m > L_{m-1} \end{cases}$$

(4)
$$p(i | L_m) = e^{-\mu L_m} (1 - e^{-\mu L_m})^{i-1}$$

(5)
$$p'(L | L_m) = \mu (1 - e^{-\mu L_m}) e^{-\mu[L_m + L]} e^{-\mu L_m} + e^{-\mu L_m} u_0(L)$$

Proof:

Let us consider the m^{th} busy period in node k . We assume that there are m_k messages included in this period. Note that $g_{kn} = 0$ for all messages grouped in a busy period, except for the message which initiates the busy period. With this condition, Eq. 3.9 states that, for $k \geq 2$

$$w_{kn} = w_{k, n-1} - g_{k-1, n}$$

and so, we see that, for $k \geq 2$,

$$w_{k1} \geq w_{k2} \geq \dots \geq w_{km_k} \quad (3.14)$$

Now, since $g_{kn} = 0$ within the busy period, we obtain from Eq. 3.7

$$a_{k+1, n} = v_n$$

Clearly, since w_{kn} is made up of transmission time (v_n) plus queueing time,

$$v_n \leq w_{k+1, n}$$

Thus,

$$a_{k+1, n} \leq w_{k+1, n}$$

Applying Eq. 3.14, we obtain

$$a_{k+1, n} \leq w_{k+1, n} \leq w_{k+1, n-1}$$

From this and Eq. 3.10, we find that $g_{k+1, n} = 0$. Applying this to Eq. 3.9, and recalling that $g_{kn} = 0$ within the busy period, we obtain, for $k \geq 2$,

$$w_{k+1, n} = w_{k+1, n-1} \quad (3.15)$$

Summarizing, Eq. 3.14 states that all messages in a busy period have monotonically decreasing waiting times. Further, Eq. 3.15 states that after messages which are grouped into a busy period pass through the next node, all these messages will have

identical waiting times. In passing through this node, new messages may be added to the busy period, and the waiting time for these need only obey Eq. 3.14; however, only messages with $v_n \leq w_{k1}$ can possibly join this group in the busy period (due to Eq. 3.14). Thus, after passing through an unbounded number of nodes, all messages in a busy period will have identical waiting times, each equal to $w_{k1} = v_1$, for $k \geq 2$. Thus, $L_m = L_{m2} = w_{k1}$. This proves statement 1 of the theorem.

We now observe that in passing through a node, the initiating message of the m^{th} busy period (hereafter referred to as the m^{th} group leader) gets delayed by exactly L_m seconds (its own transmission time) for $k \geq 2$, and so,

$$T_{mk} = T_{m,k-1} + L_m - L_{m-1}$$

or

$$T_{mk} = (k-1)(L_m - L_{m-1}) + T_{m1}$$

Now, if $L_m - L_{m-1} < 0$, then T_{mk} will eventually go negative; but this implies that the $m-1^{\text{st}}$ and m^{th} busy periods have coalesced into one large busy period. For

$L_m - L_{m-1} > 0$, then $T_{mk} \rightarrow \infty$, and for $L_m = L_{m-1}$, $T_{mk} = T_{m1}$. From this argument, we see that as $k \rightarrow \infty$, $L_m \geq L_{m-1}$ where the subscript m refers only to distinct busy periods (by definition). We have thus established statements 2 and 3 to the theorem.

Furthermore, we see that as $k \rightarrow \infty$, the m^{th} busy period will contain only those messages which arrived at node 1 after the m^{th} group leader and before the $m+1^{\text{st}}$ group leader. This also implies, by Eq. 3.14, that $v_n \leq L_m$. Since the arrival times at node 1 are chosen independently, we easily calculate $p(i | L_m)$ as

$$\begin{aligned}
p(i | L_m) &= P_r [i-1 \text{ messages arrive, each with } v_n < L_m, n=1, 2, \dots, i-1] \\
&\quad \cdot P_r [i^{\text{th}} \text{ message has length } v_i \geq L_m] \\
&= P_r [\text{message length} \geq L_m] P_r [\text{message length} < L_m]^{i-1}
\end{aligned}$$

Due to the exponential distribution of message lengths,

$$p(i | L_m) = e^{-\mu L_m} (1 - e^{-\mu L_m})^{i-1} \quad i \geq 1$$

which proves statement 4 of the theorem.

Proceeding with $p'(L | L_m)$, we note immediately that

$$\begin{aligned}
p'(L | L_m) &= p(1 | L_m) u_0(L) + \\
&\quad p(n | L_m) P_r [\text{sum of } n-1 \text{ message lengths} = L]
\end{aligned}$$

Now, since all message lengths are independent random variables, the probability density of the sum of these $n-1$ random variables is merely the $(n-1)$ -fold convolution of their individual probability density functions. Performing this convolution on the exponentially distributed lengths, we obtain

$$p'(L | L_m) = p(1 | L_m) u_0(L) + \sum_{n=2}^{\infty} p(n | L_m) \frac{\mu (\mu L)^{n-2} e^{-\mu L}}{(n-2)!}$$

Substituting for $p(n | L_m)$ from statement 4 of the theorem, and performing the indicated summation, we arrive at the expression given by statement 5. This completes the proof of Theorem 3.1.

The interesting results which describe the behavior of message traffic in a tandem net are given by Eqs. 3.8, 3.9, 3.10, 3.11, and by Theorem 3.1.

3.3 The Two Node Tandem Net

If we limit ourselves to the study of a tandem net with $K=2$, and where we allow ourselves the possibility of $C_1 \neq C_2$, we find that we are able to carry the analysis further (although not to completion). Specifically, we are able to derive a functional equation for the Laplace transform of the joint distribution of a message's length, its time spent on the queue in the first node, and its time spent on the queue in the second node. From this, we obtain a similar transform expression for the marginal distribution of the queueing time in the second node. We obtain these transform expressions as follows.

We first introduce notation suitable for this two node case, as

x = queueing time for the $n-1^{\text{st}}$ message in node 1

y = queueing time for the $n-1^{\text{st}}$ message in node 2

q = queueing time for the n^{th} message in node 1

r = queueing time for the n^{th} message in node 2

u = bit length of the $n-1^{\text{st}}$ message

v = bit length of the n^{th} message

a = inter-arrival time between the $n-1^{\text{st}}$ and n^{th} messages to the first node

We are interested in obtaining an expression for queueing time in the second node since this is the node that is supplied with the dependent traffic. We know the waiting and queueing time for the first node since it satisfies the conditions of a single exponential channel (i. e., it is fed from an external source with the suitable independence between message lengths and inter-arrival times of messages). In solving for the queueing time in the second node, we are forced to consider the joint distribution of

the triplet (x, y, u) since it is this distribution which appears in our probability expressions below. We proceed by expressing the joint distribution of (q, r, v) in terms of the distribution of (x, y, u) ; we then take the limit of these expressions as $n \rightarrow \infty$. This results in an integral equation whose Laplace transform we then obtain.

We know that the marginal distribution of all message lengths (for example, u and v) is exponential with mean length $1/\mu$; further, the inter-arrival times, a , are also distributed exponentially with mean length $1/\lambda$. We now define a set of probability expressions,

$$P_1 = P_r [q=0, r=0, v \leq V]$$

$$P_2 = P_r [0 < q \leq Q, r=0, v \leq V]$$

$$P_3 = P_r [q=0, 0 < r \leq R, v \leq V]$$

$$P_4 = P_r [0 < q \leq Q, 0 < r \leq R, v \leq V]$$

$$P = P_r [0 \leq q \leq Q, 0 \leq r \leq R, v \leq V]$$

From these definitions, it is obvious that

$$P = P_1 + P_2 + P_3 + P_4$$

$P = P(Q, R, V)$ is the 3-dimensional cumulative probability function which we are interested in. Corresponding to P there may be defined, with the help of impulse functions, the probability density function

$$p(Q, R, V) = \frac{\partial^3 P}{\partial Q \partial R \partial V} (Q, R, V)$$

Similarly, we define

$$\begin{aligned}
 p_1(V) &= \frac{\partial P_1}{\partial V} (V) \\
 p_2(Q, V) &= \frac{\partial^2 P_2}{\partial Q \partial V} (Q, V) \\
 p_3(R, V) &= \frac{\partial^2 P_3}{\partial R \partial V} (R, V) \\
 p_4(Q, R, V) &= \frac{\partial^3 P_4}{\partial Q \partial R \partial V} (Q, R, V)
 \end{aligned}$$

It is then clear that

$$\begin{aligned}
 p(Q, R, V) &= p_1(V) u_o(Q) u_o(R) + p_2(Q, V) u_o(R) + \\
 &\quad p_3(R, V) u_o(Q) + p_4(Q, R, V)
 \end{aligned}$$

For conciseness, we define the following quantities,

$$\begin{aligned}
 V_i &= V/C_i \\
 D &= x + y + u/C_1 + u/C_2 \\
 E &= (V_1 - y)C_2 \\
 F &= (Q - x)C_1 \\
 G &= \begin{cases} 0 & Q \leq V_1(C_2/C_1) \\ Q - V_1(C_2/C_1) & Q \geq V_1(C_2/C_1) \end{cases}
 \end{aligned}$$

$$H = \begin{cases} 0 & Q \leq (C_2/C_1) (V_1+R) \\ Q - (C_2/C_1) (V_1+R) & Q \geq (C_2/C_1) (V_1+R) \end{cases}$$

Omitting the lengthy arguments involved, we present the derived expressions for p_i $i=1, 2, 3, 4$.

$$\begin{aligned} p_1(V) &= \int_{x=0}^{\infty} \int_{y=0}^{V_1} \int_{u=0}^E \mu p(x, y, u) e^{-\lambda(x+u/C_1) - \mu V} dx dy du \\ &+ \int_{x=0}^{\infty} \int_{y=0}^{V_1} \int_{u=E}^{\infty} \mu p(x, y, u) e^{-\lambda(D-V_1) - \mu V} dx dy du \\ &+ \int_{x=0}^{\infty} \int_{y=V_1}^{\infty} \int_{u=0}^{\infty} \mu p(x, y, u) e^{-\lambda(D-V_1) - \mu V} dx dy du \\ p_2(Q, V) &= \int_{x=G}^Q \int_{y=0}^{V_1 - F/C_2} \int_{u=F}^E \mu \lambda p(x, y, u) e^{-\lambda(x+u/C_1 - Q) - \mu V} dx dy du \\ &+ \int_{x=Q}^{\infty} \int_{y=0}^{V_1} \int_{u=0}^E \mu \lambda p(x, y, u) e^{-\lambda(x+u/C_1 - Q) - \mu V} dx dy du \\ p_3(R, V) &= \int_{x=0}^{\infty} \int_{y=0}^{V_1+R} \int_{u=(V_1+R-y)C_2}^{\infty} \mu \lambda p(x, y, u) e^{-\lambda(D-V_1-R) - \mu V} dx dy du \\ &+ \int_{x=0}^{\infty} \int_{y=V_1+R}^{\infty} \int_{u=0}^{\infty} \mu \lambda p(x, y, u) e^{-\lambda(D-V_1-R) - \mu V} dx dy du \end{aligned}$$

$$\begin{aligned}
P_4(Q, R, V) &= \int_{x=H}^Q \int_{y=0}^{V_1+R-F/C_2} \mu\lambda C_2 p[x, y, u=C_2(V_1+R-y)] e^{-\lambda(D-V_1-Q-R)-\mu V} dx dy \\
&+ \int_{x=Q}^{\infty} \int_{y=0}^{V_1+R} \mu\lambda C_2 p[x, y, u=C_2(V_1+R-y)] e^{-\lambda(D-V_1-Q-R)-\mu V} dx dy
\end{aligned}$$

We now define the 3-dimensional Laplace transform

$$L(s_1, s_2, s_3) = \int_{Q=0}^{\infty} \int_{R=0}^{\infty} \int_{V=0}^{\infty} p(Q, R, V) e^{-s_1 Q - s_2 R - s_3 V} dQ dR dV$$

After taking transforms of the above expressions, and collecting terms, we finally obtain the following expression for $L(s_1, s_2, s_3)$.

$$\begin{aligned}
L(s_1, s_2, s_3) &= L\left[\lambda, \lambda, \frac{\lambda}{C_1} + \frac{\lambda}{C_2}\right] \frac{\mu s_2}{(s_2 - \lambda)(\mu + s_3 - \lambda/C_1)} \\
&- L\left[\lambda, (\mu + s_3)C_1, \frac{\lambda}{C_1} + (\mu + s_3)\frac{C_1}{C_2}\right] \frac{\mu\lambda s_2(\mu + s_3 - s_1/C_1)}{C_1(\mu + s_3)(s_1 - \lambda)(\mu + s_3 - \lambda/C_1)(\mu + s_3 - s_2/C_1)} \\
&+ L\left[\lambda, s_2, \frac{\lambda}{C_1} + \frac{s_2}{C_2}\right] \frac{\mu\lambda(s_2 - s_1)}{\left(\mu + s_3 - \frac{s_2}{C_1}\right)(s_1 - \lambda)(s_2 - \lambda)} \\
&- L\left[s_1, s_2, \frac{s_1}{C_1} + \frac{s_2}{C_2}\right] \frac{\mu\lambda}{(s_1 - \lambda)(\mu + s_3 - s_2/C_1)} \\
&+ L\left[s_1, (\mu + s_3)C_1, \frac{s_1}{C_1} + (\mu + s_3)\frac{C_1}{C_2}\right] \frac{\mu\lambda s_2}{C_1(s_1 - \lambda)(\mu + s_3 - \frac{s_2}{C_1})(\mu + s_3)} \tag{3.16}
\end{aligned}$$

Eq. 3.16 represents the extent to which the solution has been carried. Note that for $s_1=s_2=0$, the proper marginal distribution for the message length is obtained (after taking the inverse transform, of course). Furthermore, for $s_2=s_3=0$, we obtain the expression for the transform of the marginal distribution of the queuing time in the first node*.

With $s_1=s_3=0$, we obtain an expression for the Laplace transform of the queuing time in the second node, as follows.

$$\begin{aligned}
 L(0, s_2, 0) = & L\left(\lambda, \lambda, \frac{\lambda}{C_1} + \frac{\lambda}{C_2}\right) \frac{\mu s_2}{(s_2 - \lambda)(\mu - \lambda/C_1)} \\
 & + \frac{\mu s_2}{\mu - s_2/C_1} \left[\frac{L(\lambda, \mu C_1, \lambda/C_1 + \mu C_1/C_2)}{\mu C_1 - \lambda} - \frac{L(\lambda, s_2, \lambda/C_1 + s_2/C_2)}{s_2 - \lambda} \right] \\
 & + \frac{1}{\mu - s_2/C_2} \left[\mu L(0, s_2, s_2/C_2) - \frac{s_2}{C_1} L(0, \mu C_1, \mu C_1/C_2) \right] \quad (3.17)
 \end{aligned}$$

This functional equation has not been solved.

It is interesting to note that even the solution for the marginal distribution of the queuing time in the second node escapes us. Furthermore, we observe that the case under consideration is the simplest one in which the effect of the dependency between the inter-arrival times and lengths of messages may be analyzed; and yet, a solution was not obtained.

* Note that after multiplying this by the transform of the service time distribution, we obtain the transform of the total time spent in the first node. Inverting this product, we arrive at an expression which agrees with Eq. A.5 in Appendix A.

3.4 The Independence Assumption

We recognize that the source of difficulty in solving the general net (or even the simpler tandem net) lies in the assignment of a permanent length to each message. This permanent assignment gives rise to a dependency (see, for example, Eq. 3.4) between the inter-arrival times and lengths of adjacent messages as they travel within the net. Indeed, as we shall see below, the elimination of this dependency simplifies the mathematics considerably.

Recall the assumption of independence between the arrival time and length of a message as it enters the net from an external source. We stated that this assumption is quite accurate in describing the externally applied traffic for some communication nets. We may now inquire as to what properties of the external traffic bring about this independence. The answer is straightforward, and may be found by observing that the external message source consists of a large number of subscribers (people) each individually generating messages (telegrams) at a relatively small rate. The inter-arrival times and lengths of messages generated by any individual are indeed dependent in a manner not unlike that expressed by Eq. 3.4*. However, the collective inter-arrival times and lengths of messages generated by the entire population of subscribers exhibit an independence since the length of a message generated by any particular subscriber is completely independent of the arrival time of messages generated by the other subscribers.

A similar situation exists for the internal traffic of many practical store-and-forward communication nets. That is, there is, in general, more than one channel

* That is, any individual requires a finite amount of time to generate a message, and the length of this interval of time is strongly dependent upon the length of the message.

delivering messages into any particular node (in addition to those messages arriving from the external source feeding this node). Furthermore, there is, in general, more than one channel transmitting messages out of this node (in addition to the "virtual" channel which removes those messages which had this node as a final destination). Fortunately, (for analytical purposes), this multiplicity of paths in and out of each node considerably reduces the dependency between inter-arrival times and lengths of messages as they enter various channels (or queues) within the net. We offer evidence of this essential independence with the experimental results described in the next section.

If, indeed, this assumption of independence describes the general network behavior to a fair degree of accuracy, and if, at the same time, this assumption simplifies the mathematics, then we have good reason to accept the assumption. Specifically, one way in which we can introduce this independence into the mathematical description is to make the following assumption.

THE INDEPENDENCE ASSUMPTION:

Each time a message is received at a node within the net, a new length, v , is chosen for this message from the following probability density function,

$$p(v) = \mu e^{-\mu v}$$

It is clear that this assumption does not correspond to the actual situation in any practical communication net. Nevertheless, its mathematical consequences result in a model which accurately describes the behavior of the message delay in many communication nets. Indeed, we offer evidence of this in the next section.

3.5 The Effect of the Independence Assumption

Although the strict mathematical approach to the general net has resulted in, at most, limited analytical results, we still require an answer, of some kind, to the problem of a general node configuration. We have presented a loose hueristic argument as to why the Independence Assumption represents a useful simplification of the problem. Up to now, we have offered no substantial evidence of the accuracy of this assumption. There is, at our disposal, a powerful tool with which to test the accuracy of the Independence Assumption, namely, a digital computer simulation program. The simulator is described in Appendix E.

We first describe the results of using this simulator to demonstrate the effect on message delay as we introduce additional channels leading into, and emanating from, a node. Specifically, the network configurations which were simulated are shown in Fig. 3.5. The histogram of message delay, and the average message delay were the quantities obtained from the simulation.

Note that in configurations c - h there are three depths to the net; the nodes on the left (depth 1) receive message traffic from external sources; the middle node (depth 2) receives traffic only from nodes at depth 1; and the nodes on the right (depth 3) receive traffic only from the central node at depth 2. The quantity of interest in all cases is the distribution (or histogram) of total time spent by messages in the central node at depth 2. The nodes at depth 3 serve as destinations for all messages*. In all runs, the total capacity of the net was held fixed and broken into two equal parts, each of C bits per second. The capacity was assigned so that the capacity of all channels

* That is, equal traffic rates are applied to nodes at depth 1, and each node at depth 3 serves as a destination, each receiving the same average number of messages.

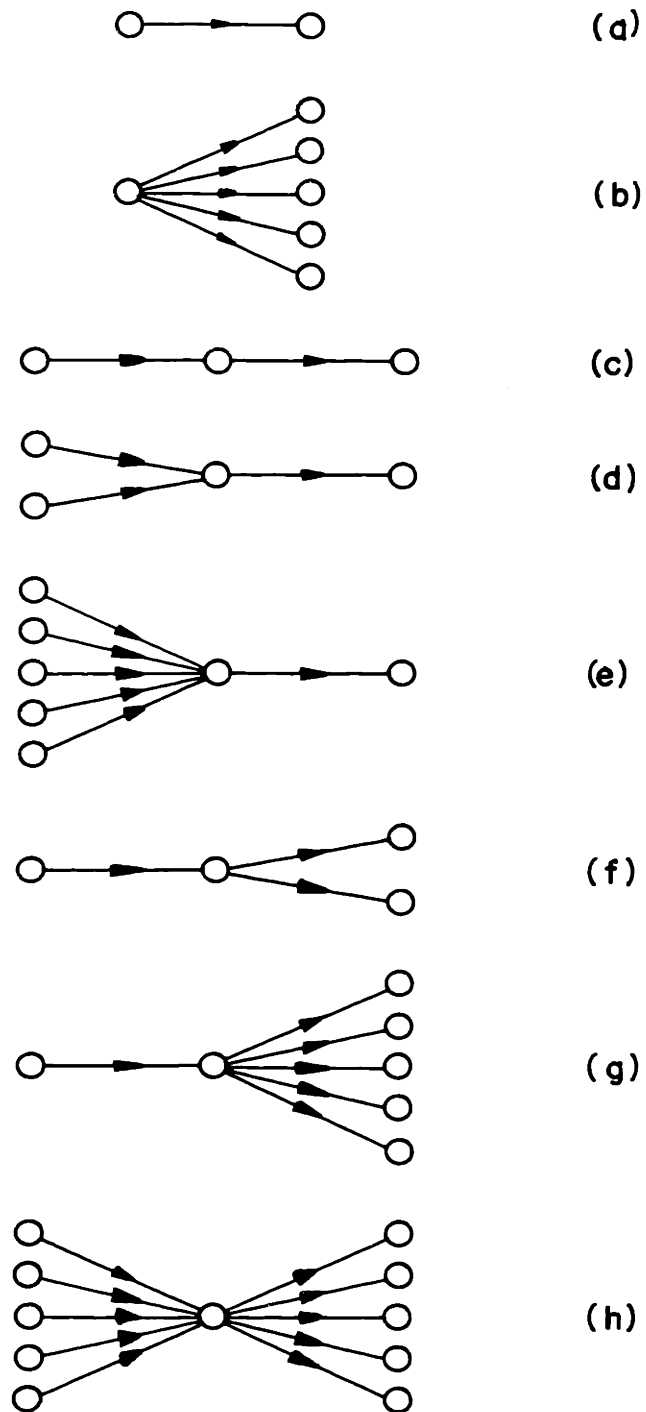

Figure 3.5 Simulated nets for studying internal network traffic

connecting depth 1 and depth 2 totalled C ; similarly, for the sum for channels connecting depth 2 and depth 3. When more than one channel connected adjacent depths, the capacity C was split equally among these channels. These same comments apply to configurations a and b, except that the node at depth 2 is omitted.

Figure 3.6 shows the results of the simulation. Figures 3.6 a and b show the histogram of message delay in passing through the first node for the net in Figs. 3.5 a and b. All other parts of Fig. 3.6 show the histogram of message delay in passing through the single node at depth 2. In all cases, the quantity $\rho = \gamma / \mu C$ is displayed on the histogram itself, where ρ pertains to a single channel emanating from the black node.

Note that Figs. 3.6 a and b are essentially exponential distributions as, of course, they should be (see Eq. A.5). Figure 3.6 c exposes the behavior of $p(R)$, the distribution whose analytic form we were not able to obtain. We note that as ρ increases, there is a marked difference in behavior between $p(Q)$ in Fig. 3.6 a and $p(R)$ in Fig. 3.6 c. Supplying two input channels (Fig. 3.6 d) and five input channels (Fig. 3.6 e) changes the nature of the difference between these figures and Fig. 3.6 a; however, this difference is still considerable even at moderate values of ρ .

The introduction of even two paths out of the central node at depth 2 results in a tremendous reduction in the difference between the behavior of the first and second nodes. Adding five exits from this node increases the similarity even further. In fact, at this point, one is hard pressed to distinguish between Figs. 3.6 a, 3.6 b, and 3.6 g. Figure 3.6 h shows, for completeness, the five input - five output case, which behaves very much in the same way as the one input - five output case shown in Fig. 3.6 b. The horizontal distance between bars on each histogram indicates the scale expansion used in displaying the histogram; that is, the spacing between adjacent bars represents one unit of delay.

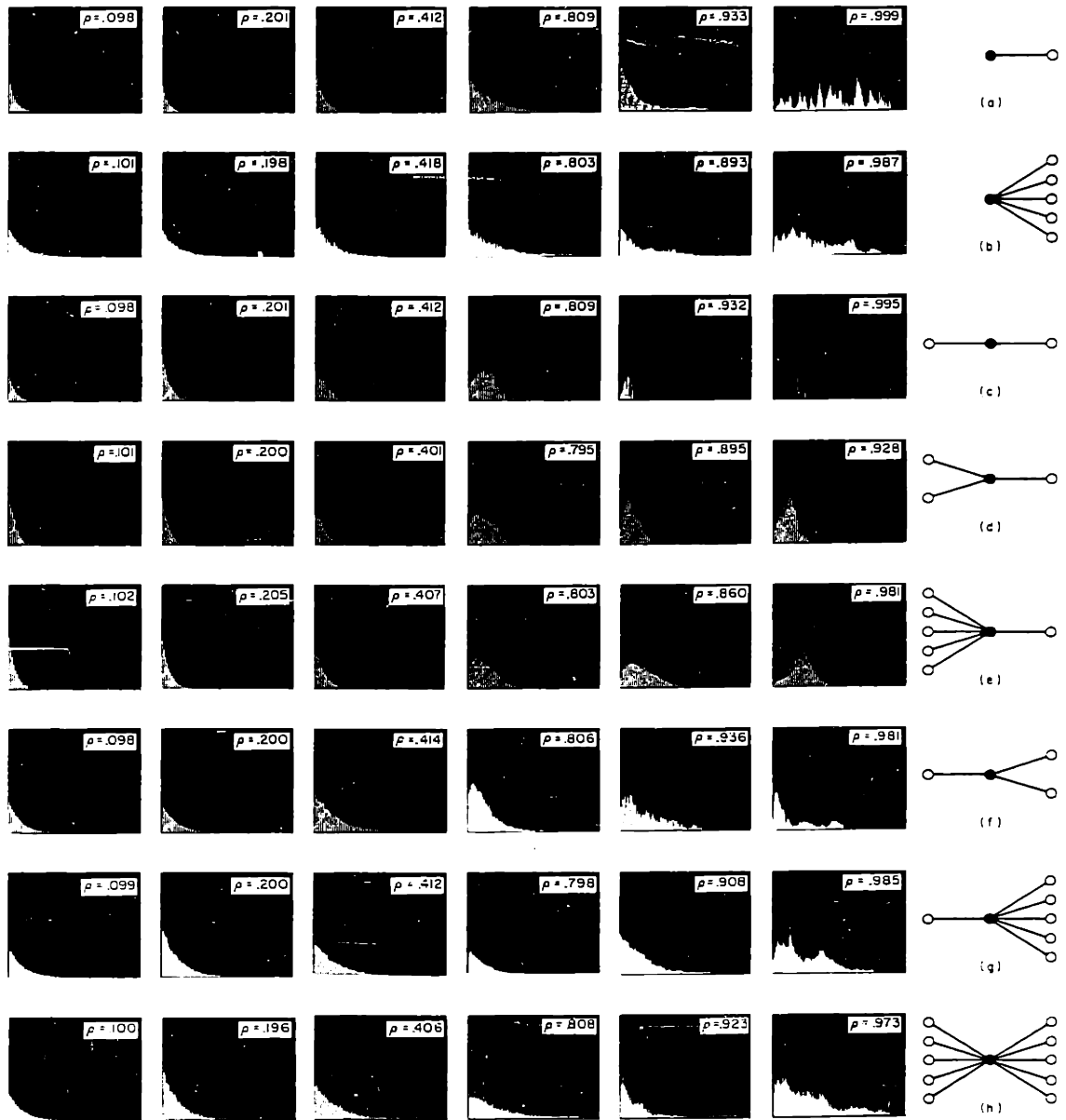

FIG. 3.6 HISTOGRAMS OF MESSAGE DELAY FROM DIGITAL SIMULATION
(the histograms pertain to delay in the black nodes)

In Fig. 3.7 we plot the average message delay for these configurations as obtained from the simulation*. This figure gives quantitative reference to the comments made above. In particular, we note the essential similarity of the average message delay for configurations a, b, f, g, h.

Having shown experimentally, that the behavior of the message delay for a single node carrying internal traffic (with a multiplicity of paths emanating from that node) is very much the same as that of a node supplied exclusively with external traffic, it remains to show an analogous result for the entire net. We proceed by comparing the average message delay for three different nets. Each net was simulated twice, both times under identical conditions except that in one case, the Independence Assumption was made, and in the second case it was not. The detailed description of each net is given in Sect. 7.1; for our present purposes, however, these details are not of importance. Figure 3.8 shows**the effect of introducing the Independence Assumption for a particular traffic matrix τ_1 (which represented a rather non-uniform traffic); Fig. 3.9 shows a similar graph for the uniform traffic matrix τ_3 (once again, see Sect. 7.1 for a full description of these nets and traffic matrices). The important observation to make is that in all cases, the introduction of the Independence Assumption resulted in a rather insignificant change in the average message delay.

* The quantity C_1 in this figure is taken to be the capacity of a single channel entering a node at depth 3.

**T is the message delay averaged over all origin-destination pairs, $1/\mu$ is the average message length in bits, C is the total channel capacity assigned to the net, and γ is the total number of messages/sec. entering the net from external sources.

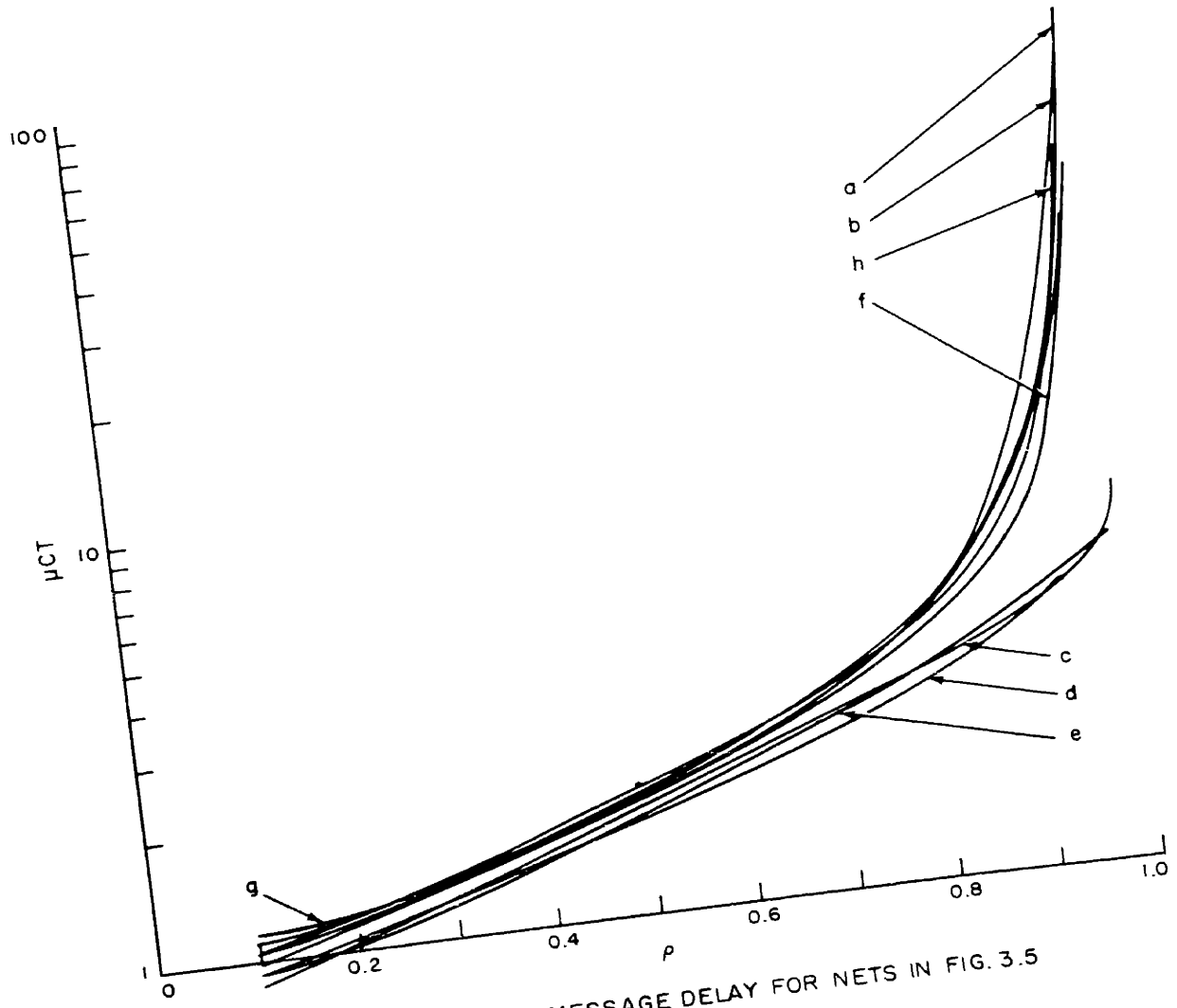

FIG. 3.7 AVERAGE MESSAGE DELAY FOR NETS IN FIG. 3.5

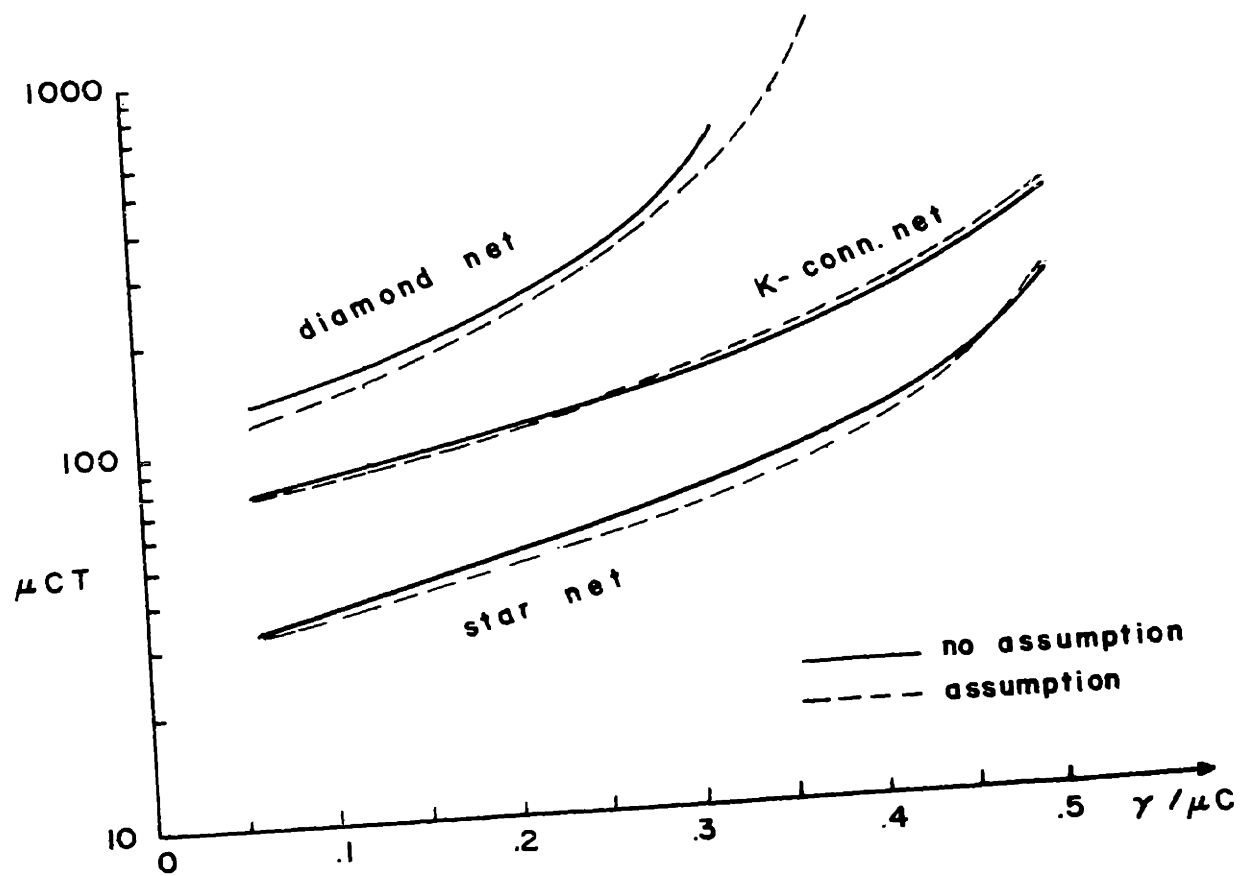

Figure 3.8 Effect of the Independence Assumption (non-uniform traffic).

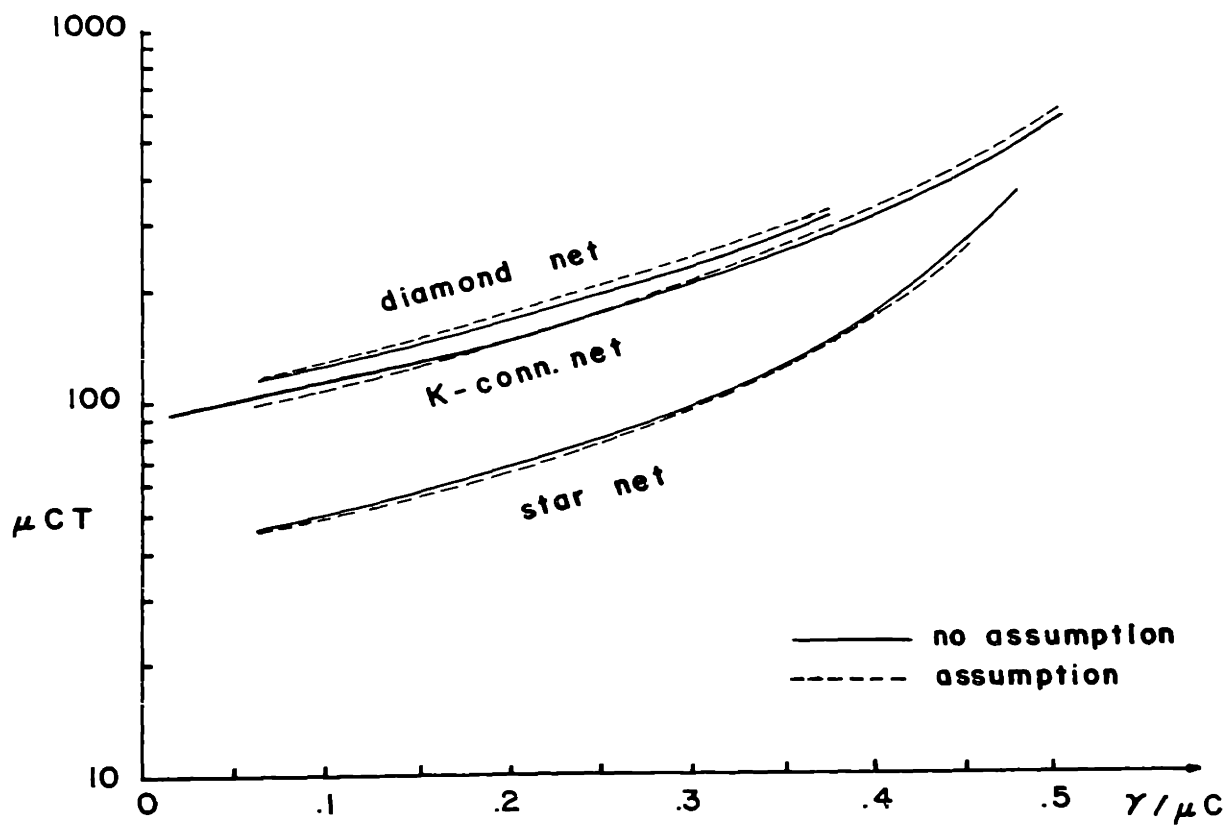

Figure 3.9 Effect of the Independence Assumption (uniform traffic).

3.6 Summary

An attempt has been made in this chapter to show the essential complexity and intractability of a direct mathematical analysis of the general communication net. Even the simpler class of tandem nets has only led to rather limited analytical results. The source of difficulty has been shown to be the dependence between the inter-arrival times and lengths of internal message traffic. We have found, however, that the introduction of the Independence Assumption removes this dependency, and produces a model which behaves essentially the same as the original model in terms of the average message delay.

It is now appropriate to discuss the mathematical model which results from the introduction of the Independence Assumption. Specifically, if we consider only fixed routing procedures, we recognize that the internal traffic flowing into each channel is statistically equivalent to the external traffic entering the net, i. e., the inter-arrival times and message lengths are independent and are chosen from exponential distributions. Thus, each channel satisfies the conditions of the single exponential channel described in Appendix A. This observation, coupled with Theorem A.1 (due to Burke) allows us to consider each channel (or node) separately in the mathematical analysis; the results of this individual analysis of course must yield the same equations described in Appendix A (i. e., for the single exponential channel). We cannot, however, stop here and consider that we have answered the designer's questions as posed in Sect. 1.2. We must consider the effect of various channel capacity assignments, routing procedures, topological structures, and priority disciplines, as well. Fortunately, these considerations are vastly simplified by the use of the Independence Assumption. We

note at this point that the introduction of various alternate routing procedures may easily complicate the mathematics once again; we therefore find that we still rely on the simulation procedure for results in many cases.

CHAPTER IV

SOME NEW RESULTS FOR MULTIPLE CHANNEL SYSTEMS

We recognize that the problems associated with a multi-terminal communication net appear to be too complex for analysis in an exact mathematical form. That is to say, the calculation of such things as the multi-variate distribution of traffic flow through a large (or even small) network is extremely difficult*. However, the introduction of the Independence Assumption into our model simplifies matters considerably. Specifically, we are now able to carry out an analysis of message delay on a node by node basis, as discussed in Sect. 3.6.

In the present chapter, we derive some new results for simple multiple channel systems, and consider optimum channel capacity assignments. As a preface, we briefly state the problems considered and the solutions obtained herein. Specifically, we present a canonical representation for the utilization factor in a single node system which has N output channels, each of arbitrary channel capacity. We then proceed to determine that number, N , of output channels from a single node in order to minimize the time that a message spends in the node, subject to the constraint that each channel is assigned a capacity C/N . A set of trading relations among message delay, channel capacity, and total traffic handled is developed next from some well-known equations. A result is then obtained which gives the assignment of channel capacity to a set of N independent single output channel nodes which minimizes the message delay averaged over the set of N nodes, subject to the constraint that the sum of the assigned channel capacity is constant. In addition, the optimum assignment of the traffic pattern is discussed, under some interesting constraints. We then consider the more general

* As discussed at length in Chap. III.

case of an interconnected net, subject to a fixed routing procedure, and find that the optimum channel capacity assignment is the same as for the unconnected net; the expression for average message delay now involves a new quantity, \bar{n} , which is the average path length for messages. Finally, we generalize the cost function applied to the previous results and conclude with a theorem which describes the optimum channel capacity assignment for this case.

4.1 A Canonical Representation for the Utilization Factor

Whereas it is well-known that, for a single channel system, the utilization factor, ρ , turns out to represent the fraction of time that the channel is in use, there has not been a similar representation available for a general multiple channel system*. One suspects that there should be an extended interpretation for such a system, and indeed, this is true, as stated in

THEOREM 4.1**

Consider an N channel service facility of total capacity C bits per second (the distribution of the total capacity C among the N channels being completely arbitrary), with Poisson arrivals at an average arrival rate of λ messages per second, message lengths distributed exponentially with mean length $1/\mu$ bits, and an arbitrary queue discipline (with the restrictions that there be no defections from the system, and, if pre-emption is allowed, it must be pre-emptive resume[†]). Define, as usual, the utilization factor

* For the special multiple channel case wherein all channels have identical capacities (as in Sect. 4.2), it is well-known (see, for example Morse [19, p.102] that ρ is the average fraction of busy channels. We are giving a more general result which allows an arbitrary distribution of capacity among the channels.

** Appendix B contains the proof of this theorem.

† See Sect. 5.1 for a precise definition of these terms.

$$\rho = \lambda/\mu C$$

Then

$$\rho = 1 - \sum_{n=0}^{\infty} \frac{\bar{C}_n}{C} P_n \quad (4.1)$$

provided $\rho < 1$.

where

$$Q_n(x) = P_r \quad \left[\begin{array}{l} \text{the sum of the capacity of all unused channels} \\ \text{is less than } x, \text{ given that } n \text{ messages are in} \\ \text{the system} \end{array} \right]$$

$$\bar{C}_n = \int_0^C x dQ_n(x) = \begin{array}{l} \text{Expected value of the unused capacity} \\ \text{given that there are } n \text{ messages in} \\ \text{the system.} \end{array}$$

$$P_n = P_r \quad \left[\text{finding } n \text{ messages in the system in the steady state} \right]$$

Essentially, this theorem states that*

$$\rho = E(\text{used normalized capacity})$$

where the normalization is with respect to the total capacity C . This theorem not only gives one a physical interpretation of the utilization factor for a multiple channel system, but also gives an alternate analytic expression for the utilization factor which turns out to be quite useful. In particular, the proof of certain theorems in Chap. VI depend upon this representation.

* The notation $E(x)$ is to be interpreted as, expected value of x .

4.2 Optimum Number of Channels for a Single Node Facility

Consider a pair of nodes in a large communication net. When the first of these nodes transmits a message destined for the other, one can inquire as to what the rest of the net appears like, from the point of view of the transmitting node. In answer to this inquiry, it does not seem unreasonable to consider that the rest of the net offers, to the message, a number, N , of "equivalent" alternate paths from the first node to the second; the equivalence is a very gross simplification of the actual situation, which, nevertheless, serves a useful purpose. Thus, the node under consideration reduces itself to a multiple channel system. Assume that we have N channels emanating from this node, each of capacity C/N bits per second, with Poisson arrivals at an average arrival rate of λ messages per second, and with all message lengths exponentially distributed with mean length $1/\mu$ bits. The queue discipline is taken to be first come first served, wherein the message at the head of the queue accepts the first channel to become available. If a message enters the system when more than one channel is free, it chooses one from this set according to a uniform distribution*. Such an arrangement is shown in Fig. 4.1.

* Recall that we are assuming that all channels leading out of the node go to "equivalent" destinations, and so the messages are willing to accept any channel at all.

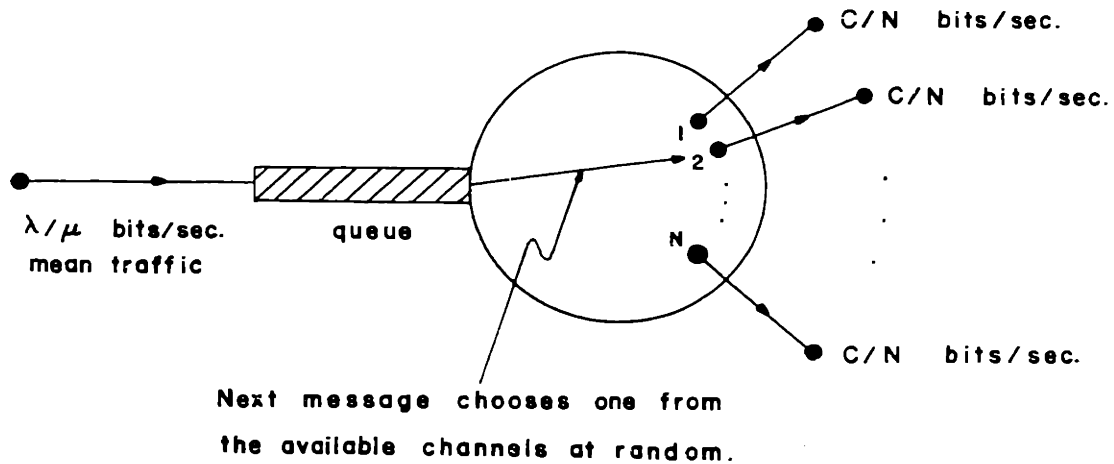

Figure 4.1 N-channel node considered in Theorem 4.2.

For given values of λ , μ , and the total capacity C , of the node, the question as to the proper choice for N (the total number of channels) presents itself*. Specifically, let us inquire as to the value of N which minimizes T , the mean total time spent in the node (i.e., time spent waiting for a free channel plus time spent in transmission over that channel). Again, we define $\rho = \lambda/\mu C$. Appendix A presents the solution for T , as well as a number of other pertinent expressions. We are now ready to state

THEOREM 4.2**

The value of N which minimizes T , for all $0 \leq \rho < 1$ is

$$N = 1$$

* Morse [19, pp. 103, 104] discusses this problem.

**See Appendix B for proof of this theorem.

The reason that a facility with more than one channel is non-optimum in the sense described above is that the efficiency of a node is related to its transmitting rate; when we have only one channel, we are guaranteed to be transmitting at a rate of C bits per second whenever there are any messages in the system, whereas when we have N channels ($N > 1$), there will be situations when we have less than N channels occupied and we will then be transmitting at a rate less than C .

This result says, in essence, that whenever possible one should design a multiple channel system (whose total capacity is fixed) with as few channels as the physical constraints of the network allow (the limiting case of one channel is, as stated above, optimum).

4.3 Trading Relations Among Rate, Capacity, and Message Delay

A consideration of the trading relations among the number of messages handled, the expected delay experienced by these messages, and the channel capacity of the facility, will now be undertaken. Let us consider two different single exponential channel facilities, as shown in Fig. 4.2. We also consider the two quantities T_i and W_i

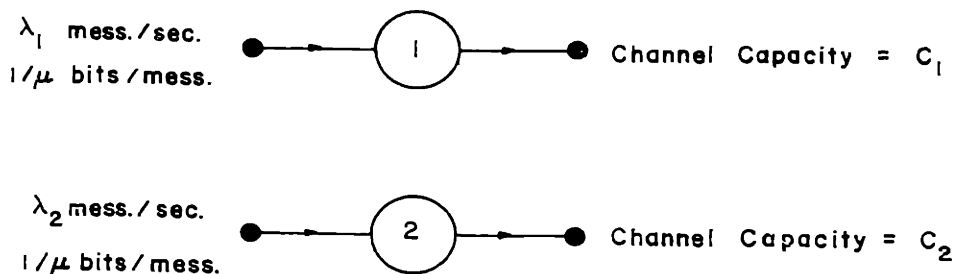

Figure 4.2 Two single exponential channel facilities.

where, once again,

$$T_i = E \text{ (total time that a message spends in passing through node } i \text{)}$$

and where we define

$$W_i = E \text{ (time that a message spends on the queue in node } i \text{)}.$$

We assume that the messages arriving at both nodes have the same average length ($1/\mu$ bits per message) but different Poisson arrival rates (λ_i messages per second).

What is of interest to us is the relative behavior of these two systems with regard to their message rate, message delay, and channel capacity. Specifically, we desire quantitative relations for λ_2/λ_1 , T_2/T_1 (or W_2/W_1), and C_2/C_1 . By straightforward use of Eq. A.6 from Appendix A, we find that

$$\frac{T_2}{T_1} = \left(\frac{C_1}{C_2} \right) \frac{1 - \rho}{1 - \frac{\lambda_2 C_1}{\lambda_1 C_2} \rho}$$

and

$$\frac{W_2}{W_1} = \left(\frac{\lambda_2 C_1^2}{\lambda_1 C_2^2} \right) \frac{1 - \rho}{1 - \frac{\lambda_2 C_1}{\lambda_1 C_2} \rho}$$

where

$$\rho = \frac{\lambda_1}{\mu C_1}$$

and

$$W_i = T_i - \frac{1}{\mu C_i}$$

If we make the substitution

$$\alpha = \frac{\lambda_2 C_1}{\lambda_1 C_2}$$

we then obtain

$$\frac{T_2}{T_1} = \left(\frac{C_1}{C_2} \right) \frac{1 - \rho}{1 - \alpha\rho} \quad (4.2)$$

and

$$\frac{W_2}{W_1} = \alpha \left(\frac{C_1}{C_2} \right) \frac{1 - \rho}{1 - \alpha\rho} \quad (4.3)$$

The general behavior of these relations is shown in Fig. 4.3. Equations 4.2 and 4.3 give the desired trading relations. Thus, the effect of varying one of the parameters may be seen quite simply from these curves.

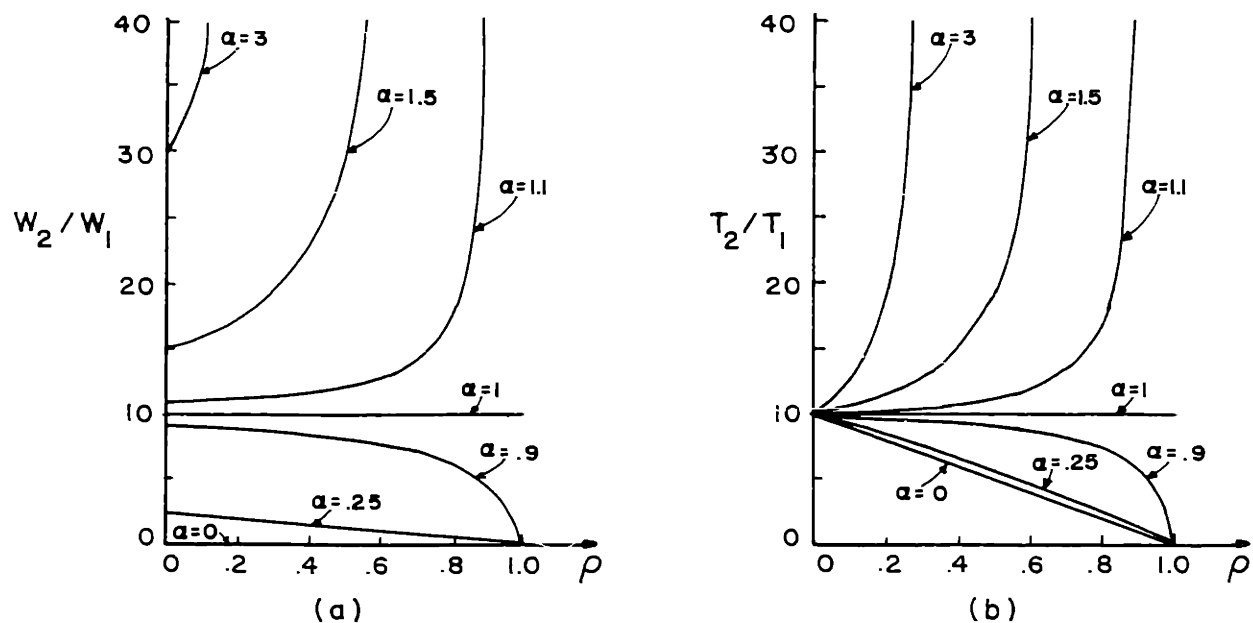

Figure 4.3 Trading curves among message delay, channel capacity, and total traffic handled.

An important observation may now be made. Let us assume that C_1 is M times as large as C_2 . Now, one might imagine that reducing the input rate of messages to the second (lower capacity) system by the same ratio (i. e., $\lambda_2 = \frac{\lambda_1}{M}$) would leave the relative message delay constant. However, it is clear from Eqs. 4.2 and 4.3 that this is not so. In particular, in this case, we see that

$$T_2/T_1 = M$$

and

$$W_2/W_1 = M$$

This result is somewhat surprising at first, and has certain implications about the design of any queueing facility. In particular, it states that large facilities with a large arrival rate of units to be serviced, perform better than small facilities with a proportionally smaller arrival rate of units*. The increase in performance is equal to the relative sizes of the two facilities, and is independent of the value of ρ .

It is also clear from the curves in Fig. 4.3 that if one desires a reduction in capacity, but no increase in message delay (i. e., $T_2 = T_1$), then there exists a range for ρ in which it is possible to reduce the input message rate sufficiently to achieve this, namely, $1 - C_1/C_2 \leq \rho < 1$.

4.4 Optimum Assignment of Channel Capacity

We first consider a situation in which there are N separate single exponential channel facilities. The i^{th} node has a Poisson arrival rate of λ_i messages per second, each message having an exponentially distributed length of mean $1/\mu_i$ bits; the channel capacity associated with the i^{th} node is C_i . All nodes behave independently of each

* Feller [13, p. 420] discusses a comparison of this type.

other; however, they are mutually coupled by the following linear constraint on their capacities:

$$\sum_{i=1}^N C_i = C \quad (4.4)$$

That is, there is distributed throughout the N channels, a total capacity of C bits per second. The system under consideration is shown in Fig. 4.4.

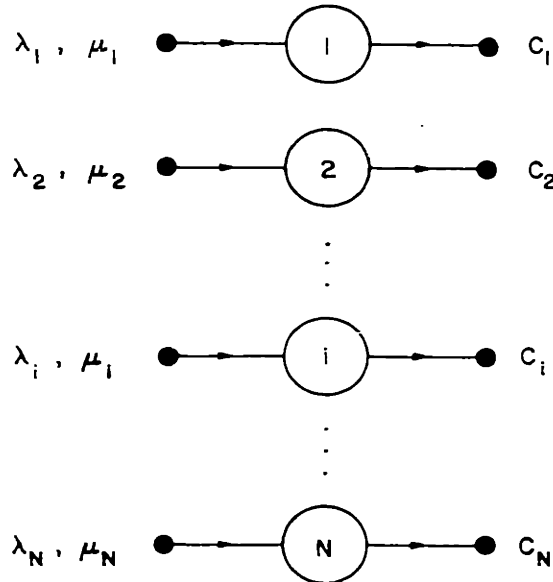

Figure 4.4 System of N separate single channel facilities.

For any assignment of the C_i which satisfies Eq. 4.4, there is defined

$T_i = E$ (total time that a message spends in passing through node i)

One may ask about that particular assignment of the C_i which satisfies Eq. 4.4 and which also minimizes the average (over the index i) of the set of numbers T_i . Specifically, we define this average to be

$$T = \sum_{i=1}^N \frac{\lambda_i}{\lambda} T_i \quad (4.5)$$

where*

$$\lambda = \sum_{i=1}^N \lambda_i \quad (4.6)$$

Note that the weighting factor λ_i/λ for T_i has been chosen in the obvious way to be proportional to the number of messages which pass through node i . The solution to this problem is stated in

THEOREM 4.3**

The assignment of the set C_i which minimizes T and which satisfies Eq. 4.4 is

$$C_i = \frac{\lambda_i}{\mu_i} + C(1-\rho) \frac{\sqrt{\lambda_i/\mu_i}}{\sum_{j=1}^N \sqrt{\lambda_j/\mu_j}} \quad (4.7)$$

provided that

$$C > \sum_{i=1}^N \frac{\lambda_i}{\mu_i} \quad (4.8)$$

* Note that $\lambda = \gamma$ in this special configuration (see definitions in Sect. 1.5).

** See Appendix B for proof of this theorem.

where

$$\rho = \lambda/\mu C \quad (4.9)$$

and

$$\frac{1}{\mu} = \sum_{i=1}^N \frac{\lambda_i}{\lambda} \frac{1}{\mu_i} \quad (4.10)$$

With this optimum assignment, we find that

$$T_i = \frac{\sum_{j=1}^N \sqrt{\frac{\lambda_j}{\mu_j}}}{C (1-\rho) \sqrt{\lambda_i \mu_i}} \quad (4.11)$$

and

$$T = \frac{\left(\sum_{i=1}^N \sqrt{\frac{\lambda_i}{\mu_i}} \right)^2}{\lambda C (1-\rho)} \quad (4.12)$$

We note that the optimum assignment operates in the following way. Each channel is first apportioned just enough capacity to satisfy its average required flow of λ_i/μ_i bits per second. After this apportionment, there remains an excess capacity $C - \sum_{i=1}^N \lambda_i/\mu_i = C (1-\rho)$ which is then distributed among the channels in proportion to the square root of their average flow λ_i/μ_i . Equation 4.8 expresses the obvious condition that there be enough capacity to begin with so as to satisfy the minimum requirements of the average flow in each node.

Having obtained the optimum assignment for C_i , we now inquire as to the optimum distribution of the λ_i . We consider the case in which $\mu_i = \mu$ for $i=1, 2, \dots, N$. In

particular, let us assume that we have some freedom in distributing the λ_i among the N nodes, subject to the constraint expressed in Eq. 4.6 and with the additional constraints that

$$\lambda_i \geq k_i \quad i=1, 2, \dots, N \quad (4.13)$$

where, for convenience, we order the subscript i such that

$$k_1 \geq k_2 \geq \dots \geq k_N \geq 0 \quad (4.14)$$

and where, obviously,

$$\sum_{i=1}^N k_i \leq \sum_{i=1}^N \lambda_i = \lambda$$

The set of numbers, k_i , represent lower bounds on the traffic flow into any node; this set of constraints corresponds to a sensible physical limitation on traffic flow. The solution to this problem is stated in

THEOREM 4.4*

The distribution of λ_i which minimizes T in Eq. 4.12 subject to the constraints expressed by Eqs. 4.6 and 4.13 is, for $\mu_i = \mu$,

$$\lambda_i = \begin{cases} \lambda - \sum_{j=2}^N k_j & i=1 \\ k_i & i=2, 3, \dots, N \end{cases} \quad (4.15)$$

Now, for all $k_i=0$ (i.e., no constraint due to Eq. 4.13), we find that all of the traffic should be assigned to (any) one of the channels, and this channel should be assigned the total capacity C . For the general case as expressed by Theorem 4.4, we see that

* See Appendix B for proof of this theorem.

after the constraint due to Eq. 4.13 is satisfied in the minimum sense (i. e. , $\lambda_i = k_i$), then all of the additional traffic should be assigned to that channel which has the largest k_i (namely, channel C_1).

We now consider the more general case of an interconnected net (as, for example, in Fig. 1.1) with N channels subject to a fixed routing procedure. Since we accept the Independence Assumption, all message lengths are chosen independently at each node from an exponential distribution. Furthermore, the externally applied traffic is Poisson in nature. Consequently, Theorem A.1 (due to Burke) is satisfied, and we find that the inter-arrival times for message arrivals throughout the net are also Poisson. This being the case, the optimum channel capacity assignment for the net, with a fixed total capacity C , is described by Eq. 4.7. The interpretation of λ_i is, as before, the average arrival rate of messages to the i^{th} channel; further, we take $\mu_i = \mu$ for all i . The average message delay, T , now must be carefully defined as

$$T = \sum_{j,k} \frac{\gamma_{jk}}{\gamma} Z_{jk} \quad (4.16)$$

where

γ_{jk} = the average number of messages entering the network per second, with origin j and destination k

$$\gamma = \sum_{j,k} \gamma_{jk}$$

and

Z_{jk} = the average message delay for messages with origin j and destination k .

That is, T is appropriately defined as the overall average message delay where the weighting factor for Z_{jk} is taken to be proportional to the number of messages which must suffer the delay Z_{jk} . For any pair, jk , the quantity Z_{jk} is composed of the sum of the average delays encountered in passing through each channel on the fixed route from node j to node k . If we break Z_{jk} into such components, and if we also form T by summing over the individual delays suffered at each channel in the net (instead of summing the delays for origin-destination pairs), we immediately see that

$$T = \sum_i \frac{\lambda_i}{\gamma} T_i \quad (4.17)$$

where clearly λ_i is the sum of all γ_{jk} for which the jk route includes channel i . Thus we note that T is defined in a consistent manner (i.e., $\lambda = \gamma$ for the net in Fig. 4.4, and so Eqs. 4.5 and 4.17 are equivalent). We may now state

THEOREM 4.5*

For a net, as described above, with a fixed routing procedure, the optimum channel capacity assignment is given by Eq. 4.7, and the average message delay, T , is

$$T = \frac{\bar{n} \left(\sum_{i=1}^N \sqrt{\frac{\lambda_i}{\lambda}} \right)^2}{\mu C (1 - \bar{n}\rho)} \quad (4.18)$$

where

$$\bar{n} = \frac{\lambda}{\gamma} = \text{the average path length for messages.}$$

* See Appendix B for proof of this theorem.

This theorem shows the strong dependence of T on the average path length, \bar{n} , as well as on the distribution of λ_i . The significance of this result is discussed in Chap. VII in conjunction with the results of the simulation experiments.

4.5 Conclusions and Extensions

A number of different questions have been posed in this chapter, and we now summarize some of the conclusions we have drawn.

In particular, if we consider the results expressed by Theorems 4.2, 4.4, and Eq. 4.2, we find a unifying conclusion: these results all indicate that delay is minimized in a queueing process when traffic is concentrated into as few channels as physically possible! The underlying constraint which forced this result to the surface is the constraint expressed in Eq. 4.4 which insists on a constant total channel capacity assigned to the system of nodes. This conclusion is verified by the simulation results presented in Chap. VII.

Furthermore, we have solved for the optimum* channel capacity assignment for a communication net with fixed routing subject to the constraint of fixed total channel capacity.

An extension to the results of Sect. 4.4 is quite interesting. Specifically, we have introduced the constraint, expressed by Eq. 4.4, which limits the total channel capacity, in bits, that may be assigned to the system. The rationale for this constraint is that the total assigned capacity is one measure of the cost of constructing the system. This function assumes no measure of the cost per unit capacity associated with each channel. Indeed, a more realistic cost function would be one which included, as a factor, some

* Optimum in the sense of minimizing the average message delay T .

function, d_i , of the i^{th} channel. In particular, we now offer as an alternative constraint to the one expressed in Eq. 4.4, the following condition:

$$\sum_{i=1}^N C_i d_i = D \quad (4.19)$$

where C_i is the channel capacity of the i^{th} transmission channel, and d_i is a function independent of the capacity C_i , and reflects the cost, in dollars say, of supplying one unit of channel capacity to the i^{th} channel. The quantity D represents the total number of dollars that is available to spend in supplying the N channel system with the set of capacities C_i ($i=1, 2, \dots, N$). In this case, we develop a theorem analogous to Theorem 4.5, as follows.

THEOREM 4.6*

The assignment of the set of channel capacities C_i to a communication net with a fixed routing procedure (such as described for Theorem 4.5) which minimizes T (see Eq. 4.17) subject to the constraint expressed in Eq. 4.19 is

$$C_i = \frac{\lambda_i}{\mu} + \left(\frac{D_e}{d_i} \right) \frac{\sqrt{\lambda_i d_i}}{\sum_{j=1}^N \sqrt{\lambda_j d_j}} \quad (4.20)$$

With this optimum assignment,

$$T_i = \frac{\sum_{j=1}^N \sqrt{\lambda_j d_j}}{D_e \sqrt{\lambda_i / d_i}} \quad (4.21)$$

* See Appendix B for proof of this theorem.

and

$$T = \frac{\bar{n} \left(\sum_{i=1}^N \sqrt{\lambda_i d_i / \lambda} \right)^2}{\mu D_e} \quad (4.22)$$

provided

$$D_e > 0$$

and where

$$D_e = D - \sum_{j=1}^N \frac{\lambda_j d_j}{\mu} \quad (4.23)$$

The analogy between Theorems 4.3, 4.5 and 4.6 is clear*. Some interesting special cases of d_i are listed below, where we define m_i as the length of the i^{th} channel.

- (1) $d_i = m_i$ This puts cost proportional to length times capacity, such as is the case for laying telephone cables, wherein the major cost is the copper cost.
- (2) $d_i = m_i^4$ This puts cost proportional to the fourth power of the length, times the capacity, which approximates the situation in an "ECHO" type passive satellite.

Obviously, the actual form of the set of cost functions, d_i , depends upon the particular communication system involved. The implications of the effect of this new constraint (Eq. 4.19) bear further investigation for future research.

* For example, Theorem 4.5 is the special case wherein $d_i = 1$ for all i .

CHAPTER V

WAITING TIMES FOR CERTAIN QUEUE DISCIPLINES

We now explore the manner in which message delay is affected when one introduces a priority structure (or queue discipline) on the set of messages in a single node facility with a single transmission (or service) channel. This chapter will present some newly derived results for certain queue disciplines; some previously published results are also included for completeness.

In communication nets, such as we are considering, messages are forced to form a queue while awaiting passage through a transmission facility, and we often find that a priority discipline describes the queue structure. The rule for choosing which message to transmit next is frequently based on a priority system similar to those studied in this chapter. Generally, one breaks the message set into P separate groups, the p^{th} group ($p=2, \dots, P$) being given preferential treatment over the $(p-1)^{\text{st}}$ group, etc. Introducing a priority structure in the message set influences the expected value of the time that each priority group spends in the queue. It is this statistic that is of interest to us, and which will be solved for. An understanding of the effects of a priority discipline at the single node level is necessary before one can make any intelligent statements about the multi-node case.

A new result for a delay dependent priority system is described, in which a message's priority is increased, from zero, linearly with time in proportion to a rate assigned to the message's priority group. The usefulness of this new priority structure is that it provides a number of degrees of freedom with which to manipulate the relative waiting times for each priority group.

An interesting new law of conservation is also proven which constrains the allowed variation in the average waiting times for any one of a wide class of priority structures.

As a result of this law, a number of general statements can be made regarding the average waiting times for any priority structure which falls in this class. A system with a time-shared service facility is also investigated. This system results in shorter waiting times for "short" messages and longer waiting times for "long" messages; interestingly enough, the critical message length which distinguishes "short" from "long" turns out to be the average message length for the case of geometrically distributed message lengths.

It is assumed throughout that the systems under consideration are in the steady state equilibrium. In general, this is equivalent to requiring that the system has been operating for a long time, and that $\rho < 1$ where ρ , once again, is the product of the average arrival rate of messages and the expected transmission time for each message. However, in some of the priority systems studied, it is possible to have $\rho \geq 1$ and still obtain a steady state type solution for some of the higher priority messages. For a full discussion of this aspect of the problem, the reader is referred to Phipps [34].

5.1 Priority Queueing

Priority queueing refers to those disciplines in which an entering message is assigned a set of parameters (either at random or based on some property of the message) which determine its relative position in the queue. This position will vary as a function of time due to the appearance of messages of higher priority in the queue. At any time t , the priority of a particular message is calculated as a function of the assigned parameters; the higher the value obtained by this function, the higher the priority. That is, the notation used is such that a message with priority q_2 is given preferential treatment over a message with priority q_1 where $q_2 > q_1$. For the fixed priority system discussed presently, this means that a message from the p^{th} priority

group has a higher priority than a message from the $p-1^{\text{st}}$ group. Whenever a tie for highest priority is met, the tie is broken by a first come first served doctrine.

Let there be a total of P different priority classes. Messages from priority class p ($p=1, 2, \dots, P$) arrive in a Poisson stream at rate λ_p messages per second; each message from priority class p has a total required processing time* selected independently from an exponential distribution, with mean $1/\mu_p$. We define

$$\lambda = \sum_{p=1}^P \lambda_p \quad (5.1)$$

$$\frac{1}{\mu} = \sum_{p=1}^P \frac{\lambda_p}{\lambda} \frac{1}{\mu_p} \quad (5.2)$$

$$\rho_p = \frac{\lambda_p}{\mu_p} \quad (5.3)$$

$$\rho = \frac{\lambda}{\mu} = \sum_{p=1}^P \rho_p \quad (5.4)$$

$$W_0 = \sum_{p=1}^P \frac{\rho_p}{\mu_p} \quad (5.5)$$

* In the application of interest wherein messages are passing through a transmission facility, the processing time (time spent in the transmission channel) is $1/\mu_p C$ where, once again, C is the capacity of the channel in bits per second, and where $1/\mu_p$ is the average message length in bits. However, for the purposes of this chapter, it is convenient to suppress the parameter C , and so we assume that $C=1$ throughout (with no loss of generality). If one wishes to reintroduce it, one need merely multiply every μ_p by C .

We further define

$$W_p = \text{Expected value of the time spent in the queue for a message with assigned parameter } p.$$

W_0 may be interpreted as the expected time required to complete service on the message found in service upon entry.

We consider four types of priority systems. In two of the systems we assume that once a message enters the processing stage, it cannot be interrupted, and the entire processing effort is devoted to completing this message's transmission. This rule defines a system with no pre-emption. In contrast to this, the other two types of queueing systems studied do allow pre-emption, i.e., a message will be taken out of the processing (or transmission) stage immediately when another message of higher priority appears in the queue. Since we assume that each message has associated with it a fixed servicing time (chosen from some exponential distribution), we therefore further assume that when a pre-empted message re-enters the service facility, its servicing is started at the point where it was interrupted when pre-emption occurred (this is referred to as pre-emptive resume)*.

The other distinguishing feature among the systems is the form of the priority assignment. In two of the systems, the priority assignment for any message remains fixed in time; that is, an entering message is assigned a number (p , say) which is to be the fixed value of its priority. We refer to such systems as fixed priority systems. In the other two systems, the priority assignment varies linearly with time. In particular, a message entering the queue at time T is assigned a number, b_p , where

* Such a procedure requires some additional bookkeeping at the transmission and receiving facilities, in order to keep track of the individual messages. We do not consider the problems associated with this bookkeeping.

$0 \leq b_1 \leq b_2 \leq \dots \leq b_p$; and the priority $q_p(t)$ at time, t , associated with that message is calculated as follows:

$$q_p(t) = (t - T) b_p \quad (5.6)$$

where t ranges from T up to the time at which this message's service is completed.

This system is referred to as a delay dependent priority system.

Thus, summarizing, the four priority systems considered are:

- (1) fixed priority system with no pre-emption
- (2) fixed priority system with pre-emption
- (3) delay dependent priority system with no pre-emption
- (4) delay dependent priority system with pre-emption.

In all four cases, whenever the system allows a new message into the processing (servicing) facility, the highest priority message is chosen.

We first consider the fixed priority system, as defined above, with no pre-emption. The results presented here are due to Cobham [35] where his notation has been altered slightly to correspond to our convention of ordering the priorities*.

THEOREM (due to Cobham)

For $0 \leq \rho$

$$W_p = \begin{cases} \frac{\rho_{j-1}/\mu_{j-1} + \sum_{i=j}^P \rho_i/\mu_i}{\left(1 - \sum_{i=p+1}^P \rho_i\right) \left(1 - \sum_{i=p}^P \rho_i\right)} & \text{for } p \geq j \\ \infty & \text{for } p < j \end{cases} \quad (5.7)$$

* Phipps [34] has used Cobham's results as a basis for the treatment of a particular variety of machine repair problems in which shortest jobs receive highest priority. His priority ordering passes, therefore, from a discrete set to a continuum.

where

$$j = \text{smallest positive integer such that } \sum_{i=j}^P \rho_i < 1$$

and

$$f = \begin{cases} 0 & \rho < 1 \\ \frac{1 - \sum_{i=j}^P \rho_i}{\rho_{j-1}} & \rho \geq 1 \end{cases} \quad (5.8)$$

Note that for $\rho < 1$, the numerator of W_p becomes merely W_0 . A graph of the family W_p is plotted in Figs. 5.2 a-d, for a particular set of parameters.

We now consider the fixed priority system with pre-emption. The results presented here were derived independently by the author, and correspond to the pre-emptive resume case considered by White and Christie [36] with exponential service times*. We define $W_p = T_p - 1/\mu_p$ where T_p is the expected value of the total time spent in the system by a message of priority p . Two forms are given for W_p ; the first is given recursively in terms of the W_i for the higher priority messages, and the second is given recursively in terms of the W_i for the lower priority messages.

* The form for W_p as given by Eq. 5.9 was published by White and Christie. The form given in Eq. 5.10 is new.

THEOREM 5.1*

For a fixed priority system with pre-emption, and $0 \leq \rho$,

$$W_p = \begin{cases} \frac{\frac{\rho_p}{\mu_p} + \sum_{i=p+1}^P \rho_i \left(\frac{1}{\mu_p} + \frac{1}{\mu_i} \right) + \sum_{i=p+1}^P \rho_i W_i}{1 - \sum_{i=p}^P \rho_i} & p \geq j \\ \infty & p < j \end{cases} \quad (5.9)$$

or

$$W_p = \begin{cases} \frac{\frac{s_j}{1-s_j} \sum_{i=j}^P \rho_i / \mu_i + \frac{\rho_p}{\mu_p} + \sum_{i=p+1}^P \rho_i \left(\frac{1}{\mu_p} + \frac{1}{\mu_i} \right) - \sum_{i=j}^{p-1} \rho_i W_i}{1 - \sum_{i=p+1}^P \rho_i} & p \geq j \\ \infty & p < j \end{cases} \quad (5.10)$$

where j is as defined above in Cobham's results, and

$$s_j = \sum_{i=j}^P \rho_i \quad (5.11)$$

Note that for $\rho < 1$, we obtain $j=1$, $s_j = s_1 = \rho$, and $\sum_{i=1}^P \rho_i / \mu_i = W_0$. A graph of the family W_p is plotted in Figs. 5.3a-d for the same parameters as Fig. 5.2.

* See Appendix C for proof of this theorem.

We next consider the delay dependent priority system. As defined, a message from the p^{th} priority group entering the queue at time T is assigned a number b_p , where $0 \leq b_1 \leq b_2 \leq \dots \leq b_p$; and the priority $q_p(t)$ at time t associated with that message is calculated from

$$q_p(t) = (t - T) b_p$$

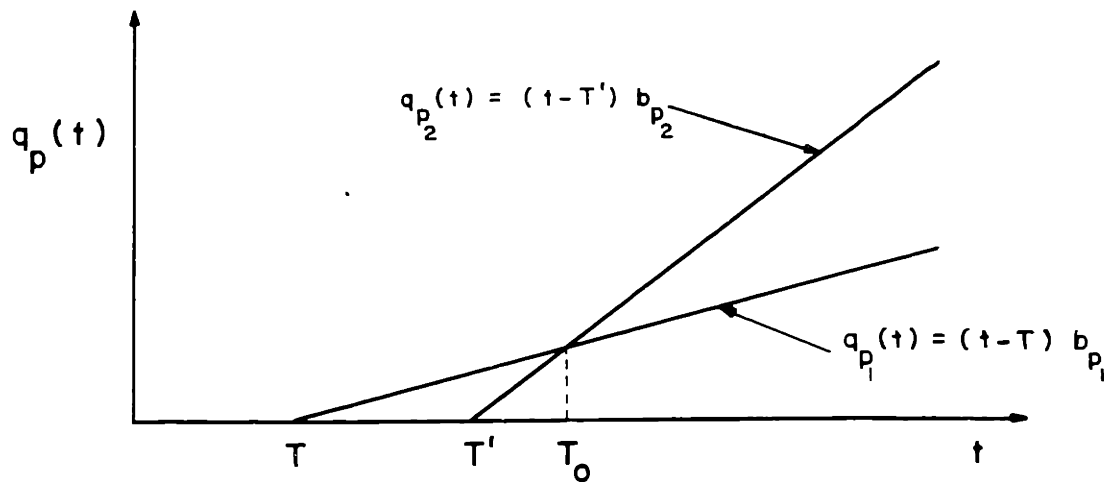

Figure 5.1 Interaction between priority functions for the delay dependent priority system.

where t ranges from T until the time at which this message's service is completed. Figure 5.1 shows an example of the manner in which this priority structure allows interaction between the priority functions for two messages. Specifically, at time T , a message from priority group p_1 arrives, and attains priority at a rate equal to $(t - T)b_{p_1}$. At time T' , a different message enters from a higher priority group p_2 ; that is, $p_2 > p_1$. When the transmission facility becomes free, it next chooses that message in the queue with the highest instantaneous priority. Thus, in our example,

the first message will be chosen in preference to the second message, if the transmission facility becomes free at any time between T and T_0 ; but, for any time after T_0 , the second message will be chosen in preference to the first message.

For the delay dependent priority system, without pre-emption, we give two derived forms for W_p ; one is a recursive form in terms of the W_i for the lower priority messages, and the other more complicated expression is the solution of the recursive equations.

THEOREM 5.2*

For the delay dependent priority system with no pre-emption, and

$$0 \leq \rho < 1,$$

$$W_p = \frac{\frac{W_0}{1-\rho} - \sum_{i=1}^{p-1} \rho_i W_i \left(1 - \frac{b_i}{b_p}\right)}{1 - \sum_{i=p+1}^P \rho_i \left(1 - \frac{b_p}{b_i}\right)} \quad (5.12)$$

or

$$W_p = \frac{W_0}{1-\rho} \left(\frac{1}{D_p}\right) \left[1 + \sum_{j=1}^{p-1} \sum_{0 < i_1 < i_2 < \dots < i_j < p} F_{i_1}^{(i_2)} F_{i_2}^{(i_3)} \dots F_{i_j}^{(p)} \right] \quad (5.13)$$

where

$$D_p = 1 - \sum_{i=p+1}^P \rho_i \left(1 - \frac{b_p}{b_i}\right) \quad (5.14)$$

and

$$F_k^{(n)} = \frac{\rho_k}{D_k} \left(1 - \frac{b_k}{b_n}\right) \quad (5.15)$$

* See Appendix C for proof of this theorem.

A graph of the family W_p is plotted in Figs. 5.4a-b. It is interesting to note the extremely simple dependence that W_p has on the parameters b_i (namely, only on their ratios).

For the case of the delay dependent priority system with pre-emption, we give a recursive form for W_p in terms of the W_i for the lower priority messages.

THEOREM 5.3*

For the delay dependent priority system with pre-emption, and for

$$0 \leq \rho < 1,$$

$$W_p = \frac{\frac{W_0}{1-\rho} + \sum_{i=p+1}^P \frac{\rho_i}{\mu_p} \left(1 - \frac{b_p}{b_i}\right) - \sum_{i=1}^{p-1} \frac{\rho_i}{\mu_i} \left(1 - \frac{b_i}{b_p}\right) - \sum_{i=1}^{p-1} \rho_i W_i \left(1 - \frac{b_i}{b_p}\right)}{1 - \sum_{i=p+1}^P \rho_i \left(1 - \frac{b_p}{b_i}\right)} \quad (5.16)$$

This family is plotted in Figs. 5.5a-b.

It is interesting to note the behavior of W_p as a function of ρ for the various disciplines discussed. The curves in Figs. 5.2-5.5 have been prepared to illustrate this behavior. The assumptions are that $\lambda_p = \lambda/P$ and $\mu_p = \mu$ ($p=1, 2, \dots, P$), and also for Figs. 5.4 and 5.5, $b_p = 2^{p-1}$. Of course, these special cases do not reveal the entire structure of the W_p , but they do give one an intuitive feeling about their general properties; the obvious reason for choosing these values is that they are easy to plot. Figures 5.2 and 5.3 show μW_p for the fixed priority system without and with pre-emption. Figures 5.4 and 5.5 similarly show μW_p for the delay dependent priority system. The curves shown are for $P = 2$ and $P = 5$. In addition, the case $P = 1$ is shown as a dashed

* See Appendix C for proof of this theorem.

curve in all the figures; clearly, for $P=1$, $\mu W_p(\rho) = \rho/(1-\rho)$ in all priority systems, and so corresponds to the strict first come first served discipline*. As such, the $P=1$ case serves as a basis of comparison for all the curves.

Observe that, in general, the curves for the pre-emptive case are more widely spaced than the corresponding curves for the nonpre-emptive case. Further, one can note that, in general, the curves for the fixed priority system are more widely spaced than the corresponding curves for the delay dependent priority system. Also note that, because of the rigid nature of the fixed priority system, some of the curves for W_p extend beyond the value of $\rho=1$. That is, although the service facility is saturated, only the lower priority groups experience an infinite expected waiting time, whereas some of the higher priority groups have a finite expected wait under this overload condition. However, the delay dependent priority system forces a fairly strong coupling (or interaction) among all the priority groups. Specifically, if any message remains in the queue for an extremely long time, it will eventually attain an extremely high value of priority; as such, it must eventually get served before any newly entering messages. Thus, if any group experiences an infinite expected waiting time, then they all do. This effect causes all the W_p curves to have a pole at $\rho=1$.

An important distinction between the two priority systems can be observed by considering the number of degrees of freedom that there are in specifying the systems. If we consider that the input traffic is specified, i.e., P , λ_p and μ_p ($p=1, 2, \dots, P$) are fixed (given) quantities, then we recognize that the fixed priority system has no degrees of freedom left, and so the W_p are completely specified. This is not a

* The conservation law presented in Sect. 5.2 shows why $\mu W_p(\rho)$ for the case $P=1$ must be independent of queue discipline.

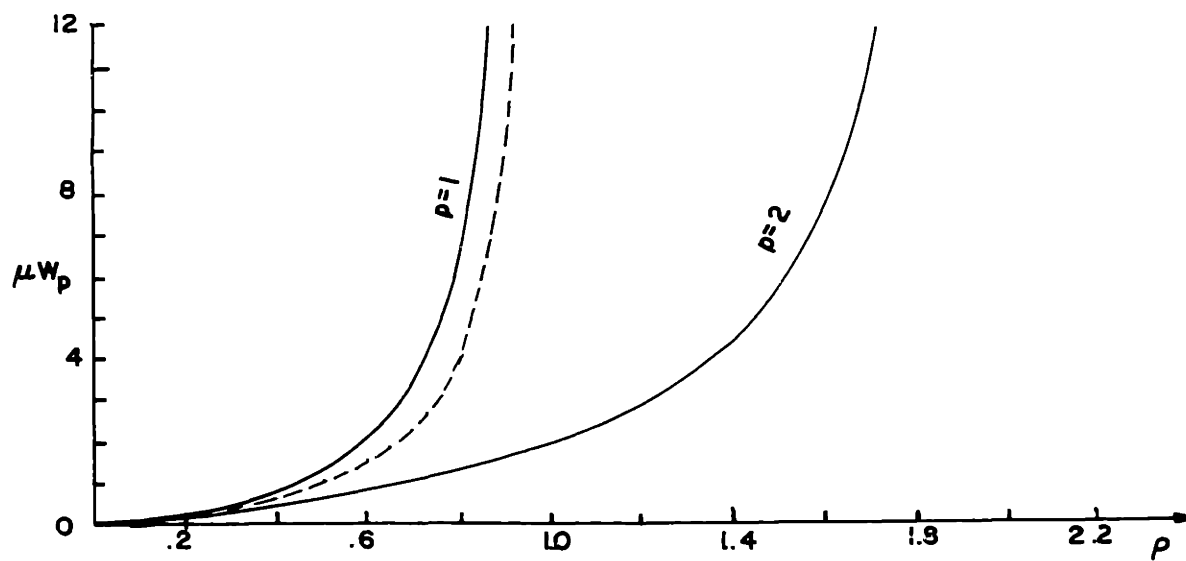

Figure 5.2a $\mu W_p(\rho)$ for the fixed priority system with no pre-emption.
 $P = 2$

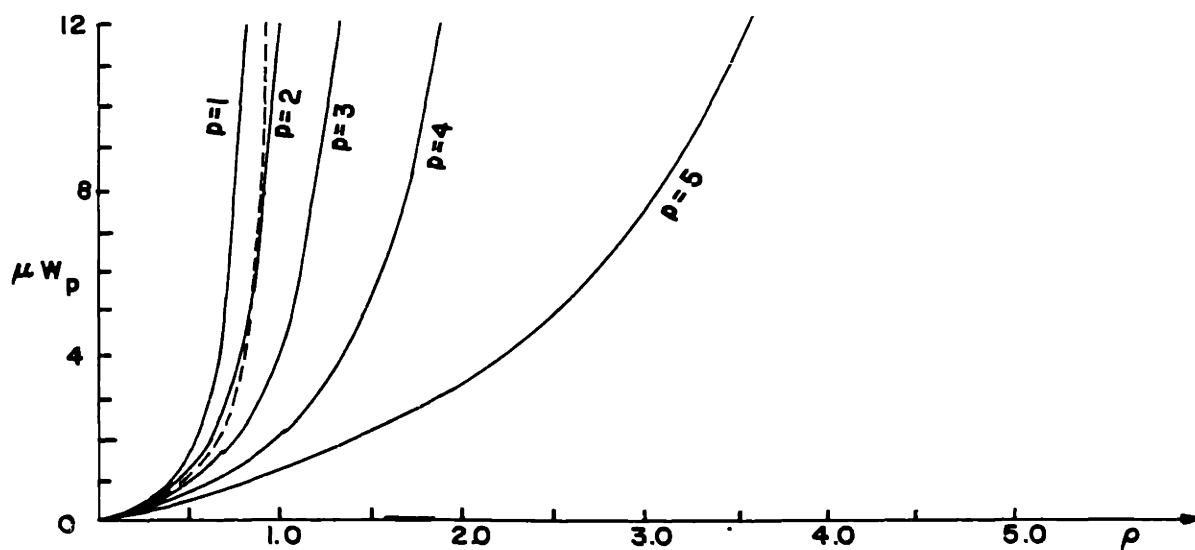

Figure 5.2b $\mu W_p(\rho)$ for fixed priority system with no pre-emption.
 $P = 5$

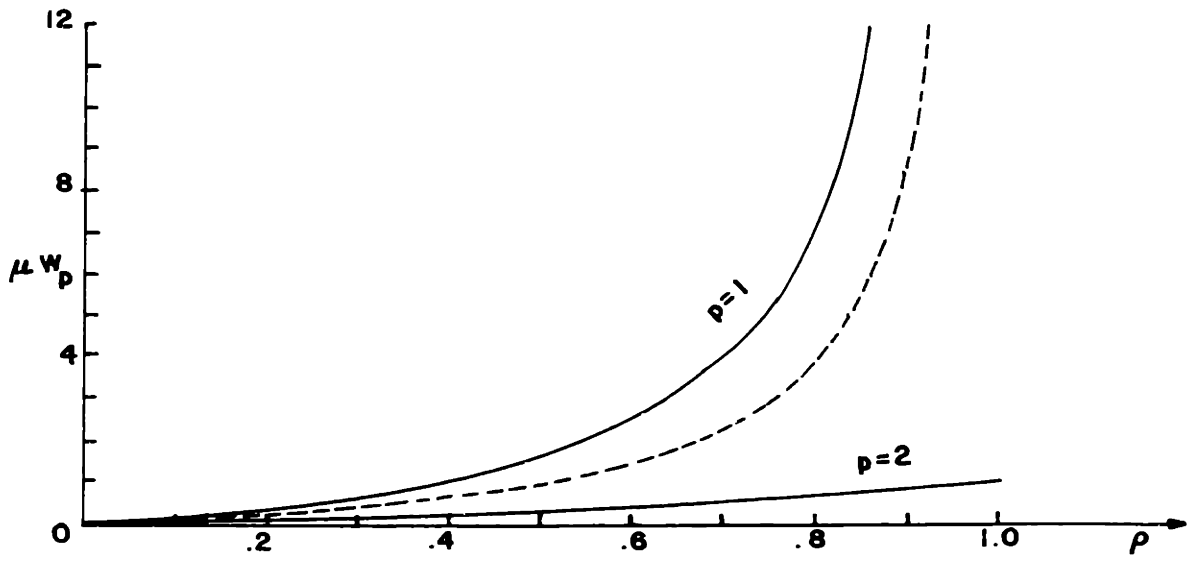

Figure 5.2c $\mu W_p(\rho)$ for fixed priority system with no pre-emption.
 P = 2 Expanded scale.

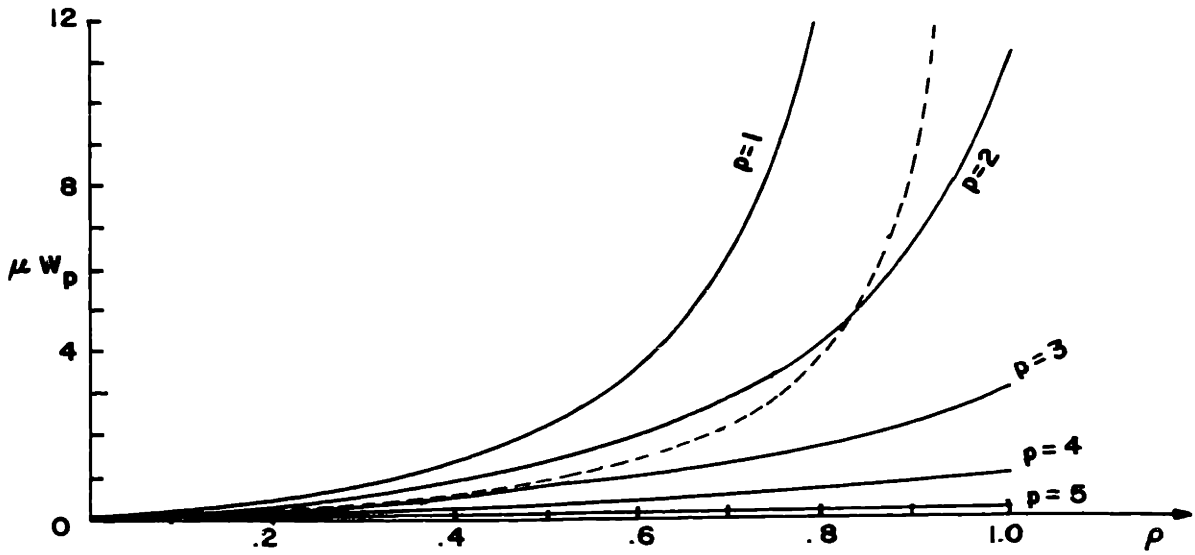

Figure 5.2d $\mu W_p(\rho)$ for fixed priority system with no pre-emption.
 P = 5 Expanded scale.

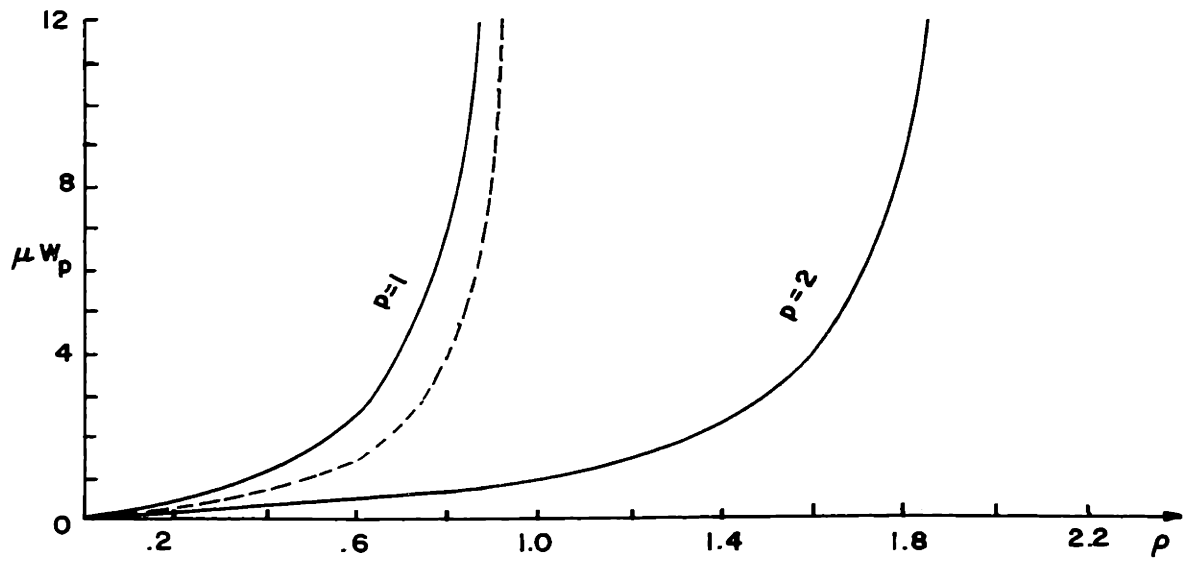

Figure 5.3a $\mu W_p(\rho)$ for the fixed priority system with pre-emption.

$P = 2$

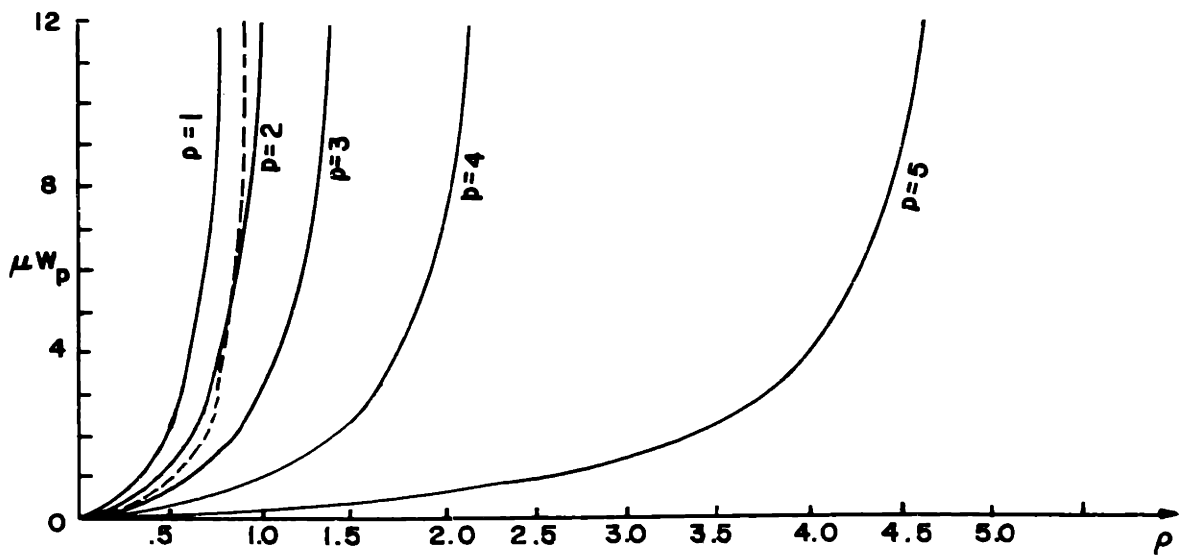

Figure 5.3b $\mu W_p(\rho)$ for the fixed priority system with pre-emption.

$P = 5$

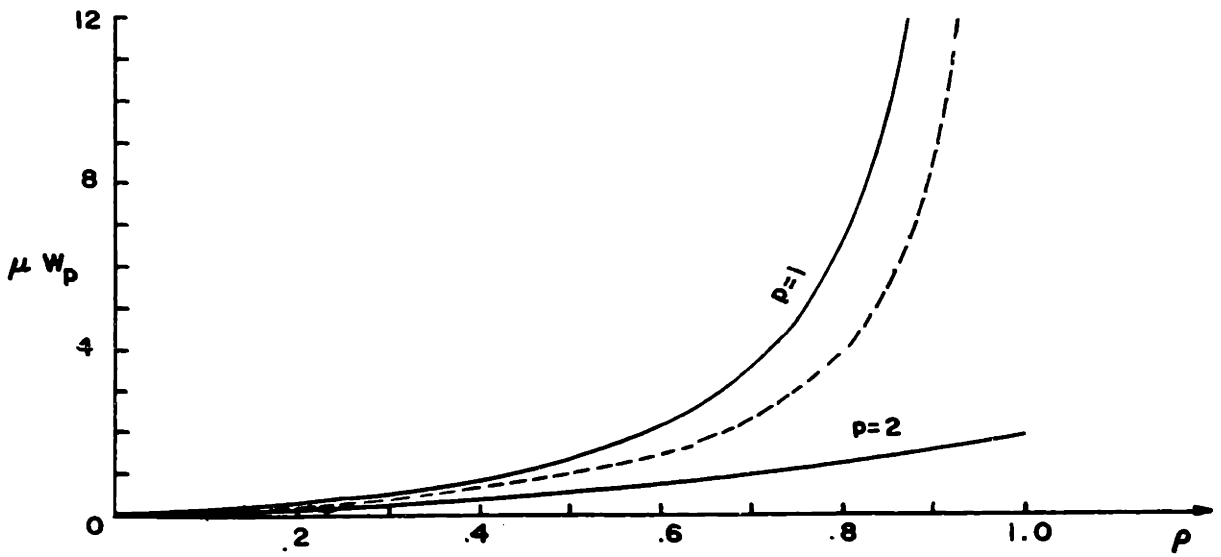

Figure 5.3c $\mu W_p(\rho)$ for the fixed priority system with pre-emption.
 $P = 2$ Expanded scale.

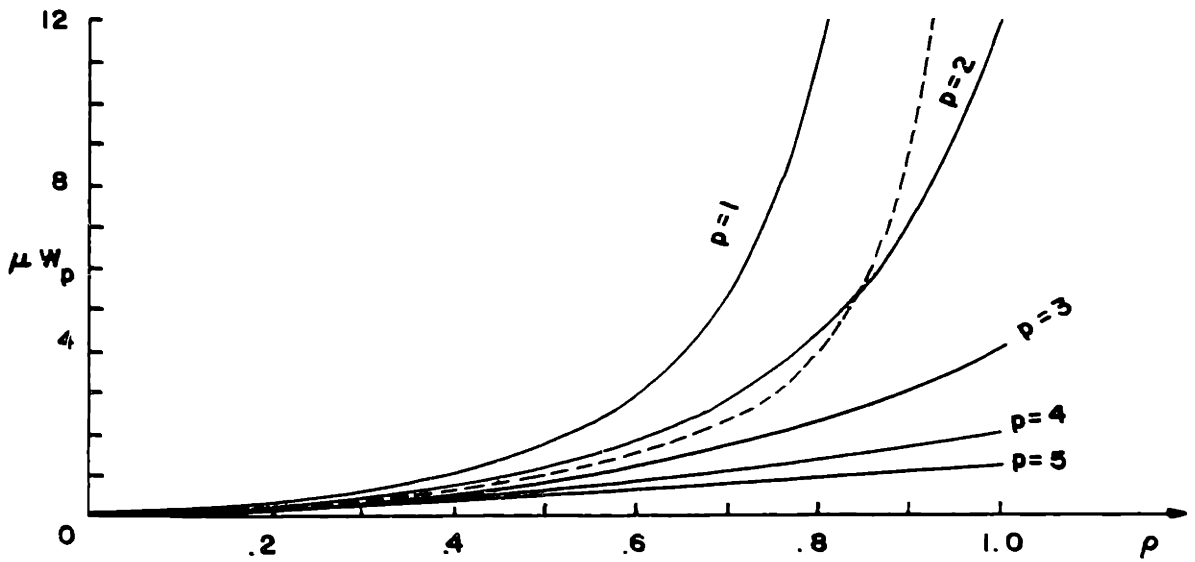

Figure 5.3d $\mu W_p(\rho)$ for the fixed priority system with pre-emption.
 $P = 5$ Expanded scale.

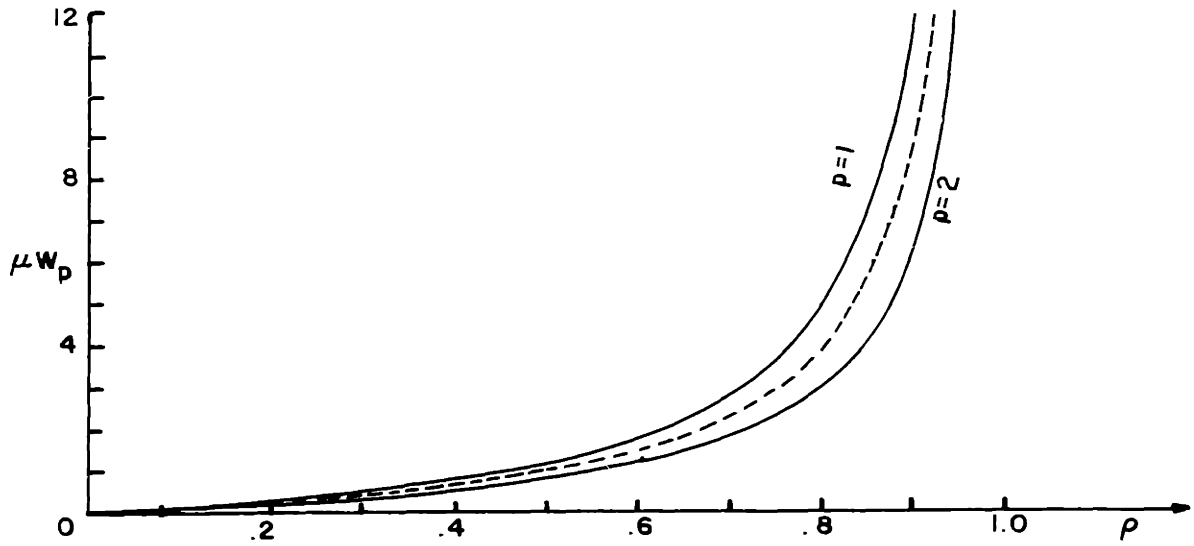

Figure 5.4a $\mu W_p(\rho)$ for the delay dependent priority system with no pre-emption.
 $P = 2$

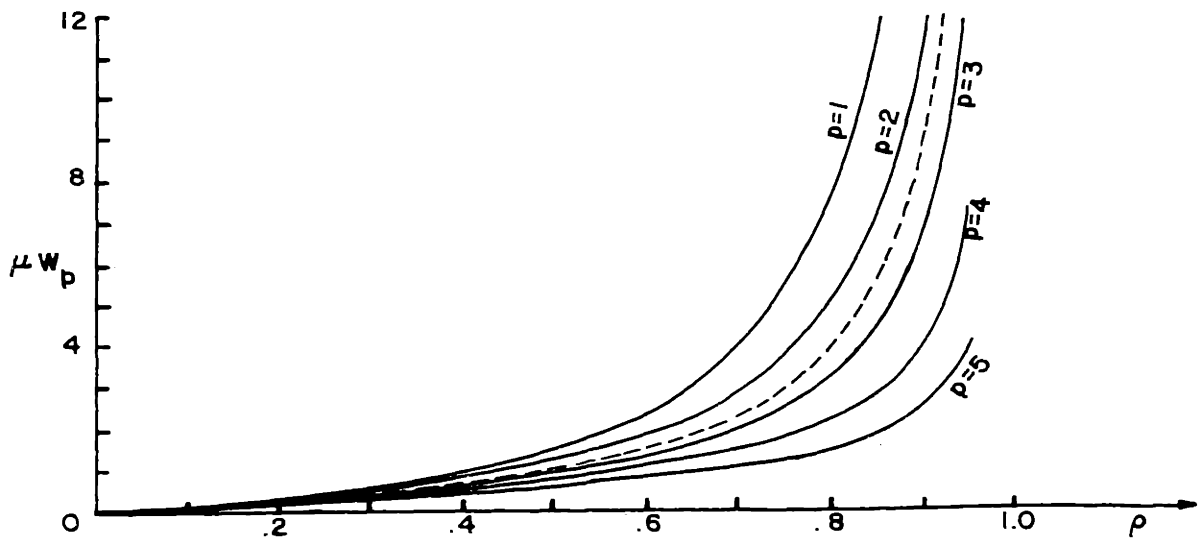

Figure 5.4b $\mu W_p(\rho)$ for the delay dependent priority system with no pre-emption.
 $P = 5$

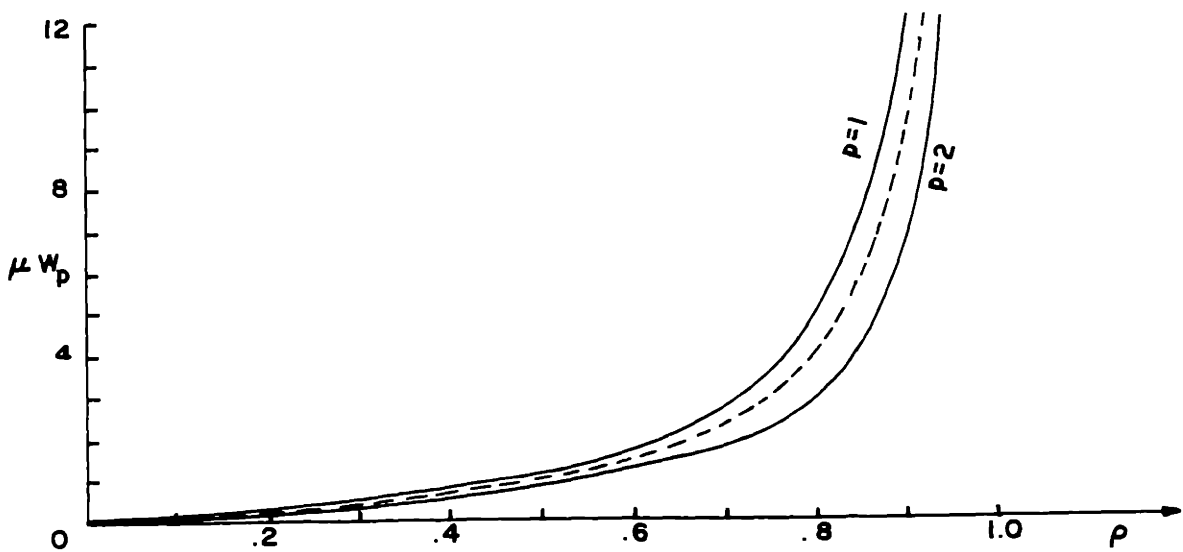

Figure 5.5a $\mu W_p(\rho)$ for the delay dependent priority system with pre-emption.

$P = 2$

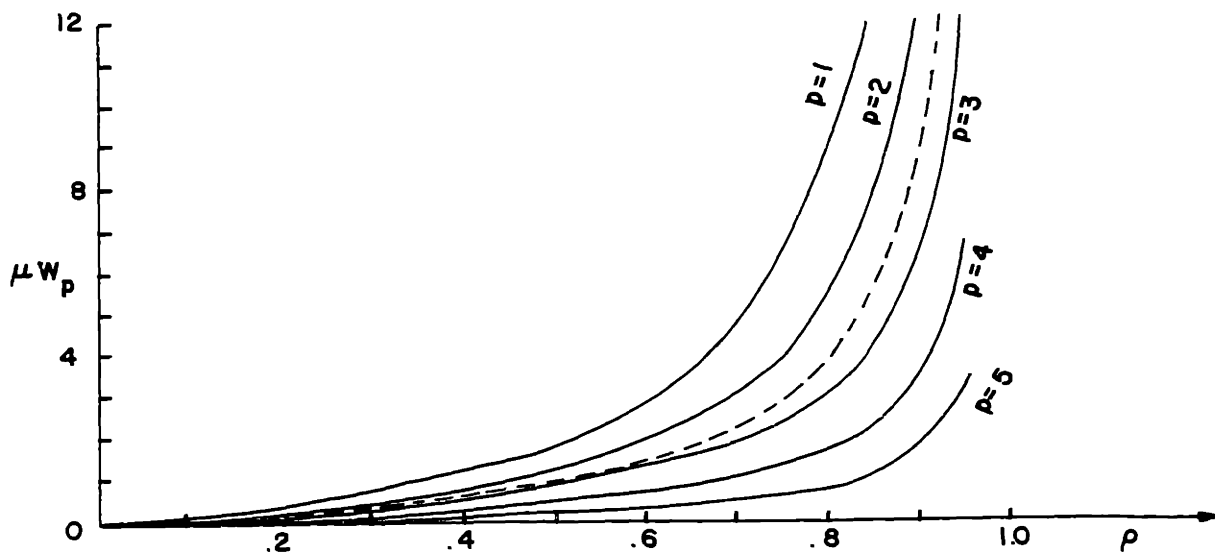

Figure 5.5b $\mu W_p(\rho)$ for the delay dependent priority system with pre-emption.

$P = 5$

desirable situation, since the system designer has no ability with which to adjust the system's behavior. However, in the delay dependent priority system, the variables b_p ($p=1, 2, \dots, P$) are at the disposal of the designer, and this variability allows adjustment of the relative spacing of the W_p to a large degree. Finally, we note that if the higher priority groups have shorter average message lengths than the lower priority groups, the average queue length is reduced.

5.2 A Conservation Law

If one studies the curves presented in Figs. 5.2-5.5, an interesting phenomenon may be observed. It appears that the curve for a strict first come first served system (the dashed curve in all the figures) lies somewhere between the curves for that of the high and low priority messages. Perhaps a conservation law is at play here, which holds constant some average value of the waiting times for the different priority groups. In fact, it is reasonable to expect such an invariance based on the simple physical argument that some messages are given preferential treatment, and so they need not wait as long as they would in a first come first served system; as a result, low priority messages are forced to wait some additional time.

Indeed, we find that there is a law of conservation which holds for the priority systems described, and, in fact, it holds for queueing systems subject to a large class of disciplines. A sufficient set of restrictions to define the class is as follows:

- (a) all messages remain in the system until completely serviced (i.e., no defections),
- (b) there is a single service facility which is always busy if there are any messages in the system,
- (c) pre-emption is allowed only if the service time distributions are exponential, and the pre-emption is of the pre-emptive resume type,

- (d) arrival statistics are all Poisson; service statistics are arbitrary; and arrival and service statistics are all independent of each other.

For such a class, the conservation law says that for a fixed set of arrival and service statistics, a particular weighted sum of the waiting times, W_p , is a constant independent of queue discipline. Once again, W_p is defined as the expected value of the time spent in the queue for a message with assigned parameter p .

THEOREM 5.4* The Conservation Law

For any queue discipline and any fixed arrival and service time distribution subject to the above restrictions,

$$\sum_{p=1}^P \rho_p W_p = \frac{\text{constant}}{\text{discipline.}} \text{ with respect to variation of the queue} \quad (5.17)$$

where P represents the total number of groups to be distinguished in the traffic**, and where

$$\rho_p = \lambda_p / \mu_p = [\text{average arrival rate of } p^{\text{th}} \text{ group} = \lambda_p] \cdot [\text{expected duration of service time for a message from } p^{\text{th}} \text{ group} = 1/\mu_p].$$

In particular, for $\rho = \sum_{p=1}^P \rho_p$, we assert that

$$\sum_{p=1}^P \rho_p W_p = \begin{cases} \frac{\rho}{1-\rho} V_1 & 0 \leq \rho < 1 \\ \infty & \rho \geq 1 \end{cases} \quad (5.18)$$

* See Appendix C for proof of this theorem. Along with the proof, we state and prove two related corollaries.

**For an explicit description of the meaning of the p subscript, see the introductory remarks in Sect. 5.1. Roughly speaking, a higher p implies a higher priority.

where

$$V_1 = \frac{1}{2} \sum_{p=1}^P \lambda_p E(t_p^2) \quad (5.19)$$

and

$$E(t_p^2) = \text{second moment of service time distribution for group } p.$$

V_1 may be interpreted as the expected time required to complete service on the message found in service upon entry, for a first come first served system. That is, convert the system at hand to one in which the same arrival and service time distributions apply, but where the entire priority and pre-emptive structure is removed and the system therefore operates on a first come first served basis. Thus, V_1 is itself independent of the particular queue discipline chosen.

Note that the conservation law constrains the allowed variation in the W_p for any discipline within the wide class considered. If we form the sum

$$\sum_{p=1}^P \frac{\lambda_p}{\lambda} W_p \quad (5.20)$$

(which weights the expected waiting time of the p^{th} priority group by its relative arrival rate λ_p/λ), the conservation law says that this sum is a constant in the case where all μ_p are equal. This sum (if multiplied by λ) represents the average number of messages in the queue (see Appendix C). If we form the time-averaged waiting time*

* Physically, we may think of this average as the following. Let us sample the system at random points in time; each time we sample, we record the time spent in the queue by the message currently being transmitted. The average value of this set of numbers is the average we are referring to.

$$\sum_{p=1}^P \frac{\lambda_p}{\lambda} \frac{1}{\mu_p} W_p \quad (5.21)$$

(which weights the W_p not only by λ_p/λ , but also by $1/\mu_p$, the average message length of a p type message), then the conservation law says that this average is a constant.

5.3 Time-Shared Service

This section presents results for a simple "round-robin" time-shared service facility, and compares these results to a straightforward first come first served discipline. The round robin discipline shares the desirable features of a first come first served principle, as well as that of a discipline which services short messages first. Such a scheme is a likely candidate for the discipline in a large time-shared computational facility.

Let time be quantized into segments each Q seconds in length. At the end of each time interval, a new message arrives in the system with probability λQ (result of a Bernoulli trial); thus, the average number of arrivals per second is λ . The service time of a newly arriving message is chosen independently from a geometric distribution such that for $\sigma < 1$

$$s_n = (1-\sigma) \sigma^{n-1} \quad n=1, 2, 3, \dots \quad (5.22)$$

where s_n is the probability that a message's service time is exactly n time units long (i. e., that its service time is nQ seconds).

The procedure for servicing is as follows: a newly arriving message joins the end of the queue, and waits in line in a first come first served fashion until it finally arrives at the service facility. The server picks the next message in the queue, and performs one unit of service upon it (i. e., it services this message for exactly Q

seconds). At the end of this time interval, the message leaves the system, if its service (transmission) is finished; if not, it joins the end of the queue with its service partially completed, as shown in Fig. 5.6. Obviously, a message whose length is n time units long will be forced to join the queue n times in all before its service is completed.

Another assumption must now be made regarding the order in which events take

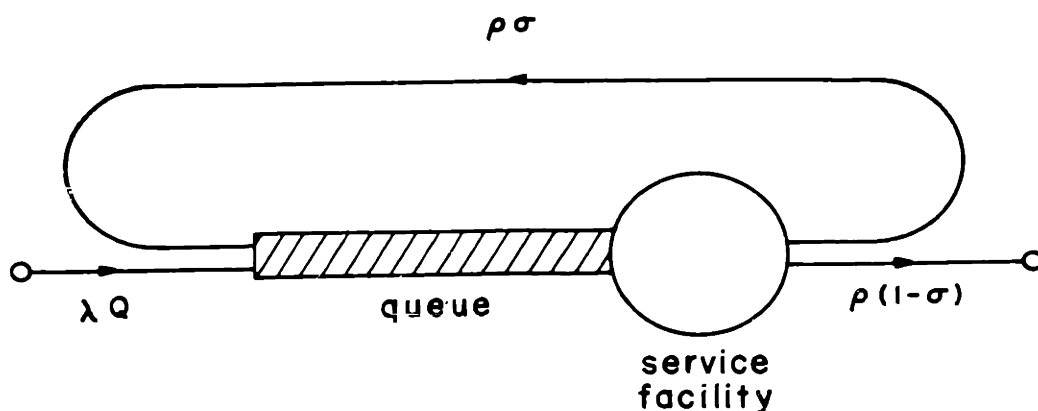

Figure 5.6 The round-robin time-shared service system.

place at the end of a time interval. We consider two types of systems. The first system allows the message in service to be ejected from the service facility (and then allows it to join the end of the queue, if more service is required for this message) and instantaneously after that a new message arrives (with probability λQ). We call this a late arrival system. The second system reverses the order in which these events are allowed to occur, giving rise to the early arrival system. In both systems, a new message is taken into service at the beginning of a time interval.

First we consider the late arrival system, which is similar to a system considered by Jackson [37] for a different class of priority systems. By straightforward techniques,

he arrives at the solution for the steady state probability, r_k , that there are k messages in the system just before the time when an arrival is allowed to occur (i.e., just after the time when a message is ejected from service if there was a message in service); Jackson's result is:

$$r_k = (1-a)a^k \quad (5.23)$$

where

$$a = \frac{\rho\sigma}{1 - \lambda Q}$$

and

$$\rho = \frac{\lambda Q}{1 - \sigma}$$

This definition of ρ is, as usual, the product of the average arrival rate λ and the mean service time, $Q/(1 - \sigma)$. The notation of Jackson's result has been altered to correspond to that used in this thesis. From this we quickly obtain* the expected value, E , of the number k as

$$E = \frac{\rho\sigma}{1 - \rho} \quad (5.24)$$

These results also apply to the time-shared service facility. For the time-shared system, we now state

THEOREM 5.5*

The expected value of the total time, T_n , spent in the late arrival system for a message whose service time is nQ seconds, is

$$T_n = \frac{nQ}{1-\rho} - \frac{\lambda Q^2}{1-\rho} \left[1 + \frac{(1-\sigma)\alpha(1-\alpha^{n-1})}{(1-\sigma)^2(1-\rho)} \right] \quad (5.25)$$

* See Appendix C for proof of this theorem.

where

$$\alpha = \sigma + \lambda Q$$

Note that $\alpha < 1$. An upper bound for T_n is easily obtained (by lower bounding the bracket above, by unity) as

$$T_n \leq \frac{Q}{1-\rho} (n-\lambda Q) \quad (5.26)$$

We now consider the early arrival system. Let r_k be the steady state probability that there are k messages in the system just after the time when an arrival is allowed to occur (i. e., just before the time when a message is ejected from service if there is a message in service). Appendix C shows that

$$r_k = \begin{cases} 1-\rho & k=0 \\ \frac{1-\rho}{\sigma} a^k & k=1, 2, \dots \end{cases} \quad (5.27)$$

where a and ρ are defined just as in the late arrival system. From this, we obtain E , the expected value of the number k as:

$$E = \frac{\rho}{1-\rho} (1-\lambda Q) \quad (5.28)$$

THEOREM 5.6*

The expected value, T_n , of the total time spent in the early arrival system for a message whose service time is nQ seconds is

$$T_n = \frac{nQ}{1-\rho} - \rho Q - \frac{\lambda Q^2 \rho}{1-\rho} \left[1 + \frac{(1-\sigma\alpha)(1-x^{n-1})}{(1-\sigma)^2(1-\rho)} \right] \quad (5.29)$$

where α is defined as before.

* See Appendix C for proof of this theorem.

An upper bound for T_n is easily obtained (by lower bounding the bracket above by unity) as

$$T_n \leq \frac{Q}{1-\rho} (n-1-\lambda Q\rho) - \rho Q \quad (5.30)$$

We now consider the case in which all messages wait for service in order of arrival, and once in service, each message remains until it is completely serviced. It is then easy to show that with T_n defined as before, we get

THEOREM 5.7*

The expected value, T_n , of the total time spent in the strict first come first serve system for a message whose service time is nQ seconds is

$$T_n = \frac{QE}{1-\sigma} + nQ \quad (5.31)$$

where

$$E = \frac{\rho\sigma}{1-\rho}$$

Note that the distinction between the early and late arrival systems has disappeared, as, of course, it must. Note also that the expression defining E is the same as that in Eq. 5.24 which is the average number of messages in the late arrival system.

Let us now compare some of these results for time-shared systems. First, we compare the value of E for the two arrival systems. Let Δ be the difference between the expected number of messages in the early and late arrival systems. Then

$$\Delta = \frac{\rho}{1-\rho} (1-\lambda Q) - \frac{\rho}{1-\rho} \sigma$$

and so

$$\Delta = \rho (1-\sigma) = \lambda Q \quad (5.32)$$

* See Appendix C for proof of this theorem.

This result is quite reasonable, since for σ equal to zero (which says that each service time equals one time interval exactly) the difference Δ should be the probability of finding a message in the early arrival system (which is merely ρ); and for σ approaching unity, the difference approaches zero since, with probability $1-\sigma$ a message will leave the system before (after) the next arrival. Note that Δ is always less than unity.

Now, if one wishes an approximate solution to the round-robin system, one might argue as follows: A message whose service time is nQ seconds must enter the end of the queue exactly n times. Roughly speaking, (this approximation is evaluated presently) each time the message enters the queue, it finds E messages ahead of it. The time spent waiting for service each time around is then approximately QE . The time actually spent in service is exactly nQ . Thus, the approximation to T_n , which we label as T_n' is

$$T_n' = nQE + nQ \quad (5.33)$$

Upon comparing this to Eq. 5.31 for the strict first come first serve system in which

$$T_n = \frac{1}{1-\sigma} QE + nQ$$

we see that for messages with length n less (greater) than $\frac{1}{1-\sigma}$ the round-robin waiting time (for the late arrival system) is less (greater) than the strict first come first serve system. However, one notes that the average length (in service intervals) is exactly $1/(1-\sigma)$. Thus, for this approximate solution, the crossover point for waiting time is at the mean number of service intervals. An evaluation of this approximation may be obtained by comparing the quantity T_n/Q as given in Eq. 5.25 and T_n'/Q as given

in Eq. 5.33. That is, the approximation is only as good as the agreement between these two (for the late arrival system*):

$$\frac{n}{1-\rho} - \frac{\lambda Q x}{1-\rho} \longleftrightarrow \frac{n}{1-\rho} - \frac{\lambda Q n}{1-\rho} \quad (5.34)$$

where

$$x = 1 + \frac{(1-\sigma)\alpha(1-\alpha^{n-1})}{(1-\sigma)^2(1-\rho)}$$

In Figs. 5.7a-c, curves of $\frac{1-\sigma}{\sigma Q} W_n(\rho)$ are plotted to show the general behavior of the round-robin structure for the late arrival system. On each graph, points corresponding to the first come first served case have also been included. The normalization factor $\frac{1-\sigma}{\sigma Q}$ is used so that in these figures, as well as in Figs. 5.2 - 5.5, the same first come first served curves, $\frac{\rho}{1-\rho}$, would appear. Further, it is important to note that μ , the average service rate, equals $\frac{1-\sigma}{Q}$ in the discrete case, and thus Fig. 5.7 plots $\frac{\mu}{\sigma} W(\rho)$ whereas Figs. 5.2 - 5.5 plot $\mu W(\rho)$. Note that the only parameter change among Figs. 5.7a-c is the value of σ .

Figures 5.7a-c indicate the accuracy of the approximation discussed above in which the crossover point for waiting times is at the mean number of service intervals, $1/(1-\sigma)$. In Figs. 5.7a,b there is no noticeable difference (on the scale used) between the first come first served points, and curve for $n = 1/(1-\sigma)$; moreover, in Fig. 5.7c the points fall between the curves for $n = 1$ and $n = 2$, since $1/(1-\sigma) = 1.25$.

It is interesting to note that both round-robin disciplines, along with the first-come first-served discipline offer an example of the validity of the conservation law,

* For the early arrival system, we compare

$$\frac{n}{1-\rho} - \frac{\lambda Q \rho x}{1-\rho} - \rho \longleftrightarrow \frac{n}{1-\rho} - \frac{\lambda Q n}{1-\rho}$$

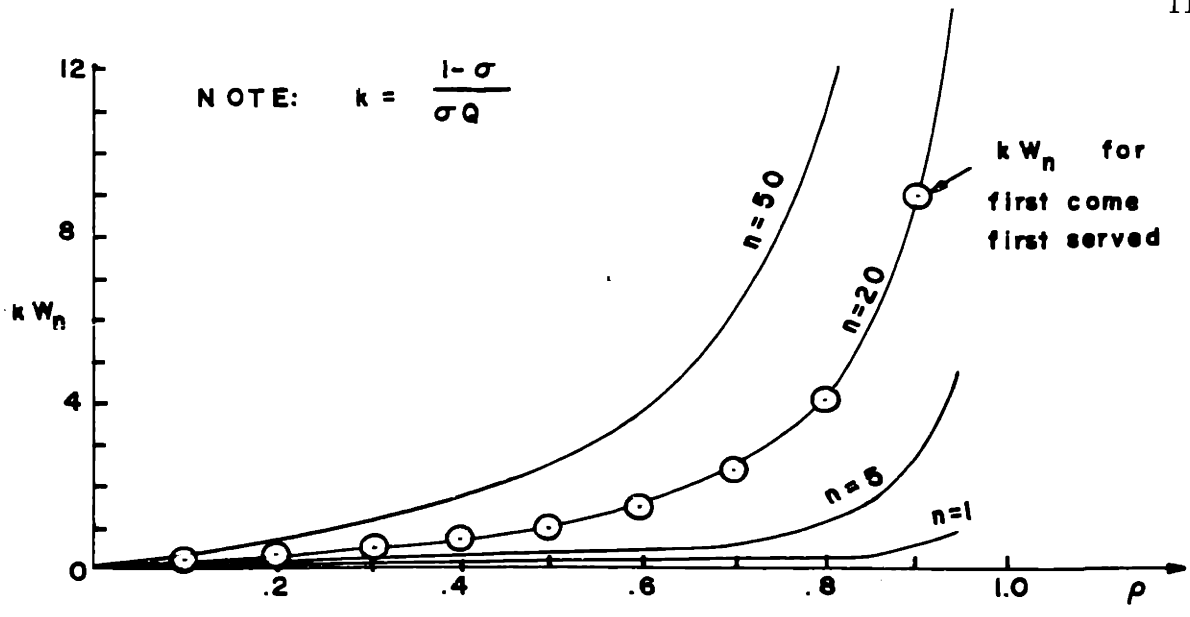

Figure 5.7a $\frac{1-\sigma}{\sigma Q} W_n(\rho)$ for the late-arrival time shared service system
 $\sigma = 19/20$

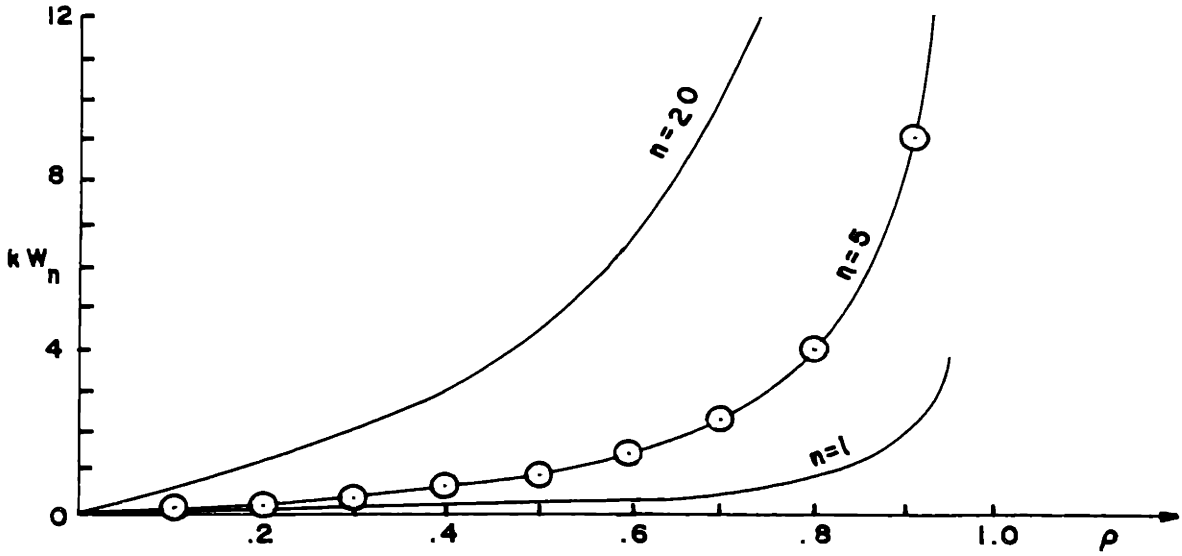

Figure 5.7b $\frac{1-\sigma}{\sigma Q} W_n(\rho)$ for the late-arrival time shared service system
 $\sigma = 4/5$

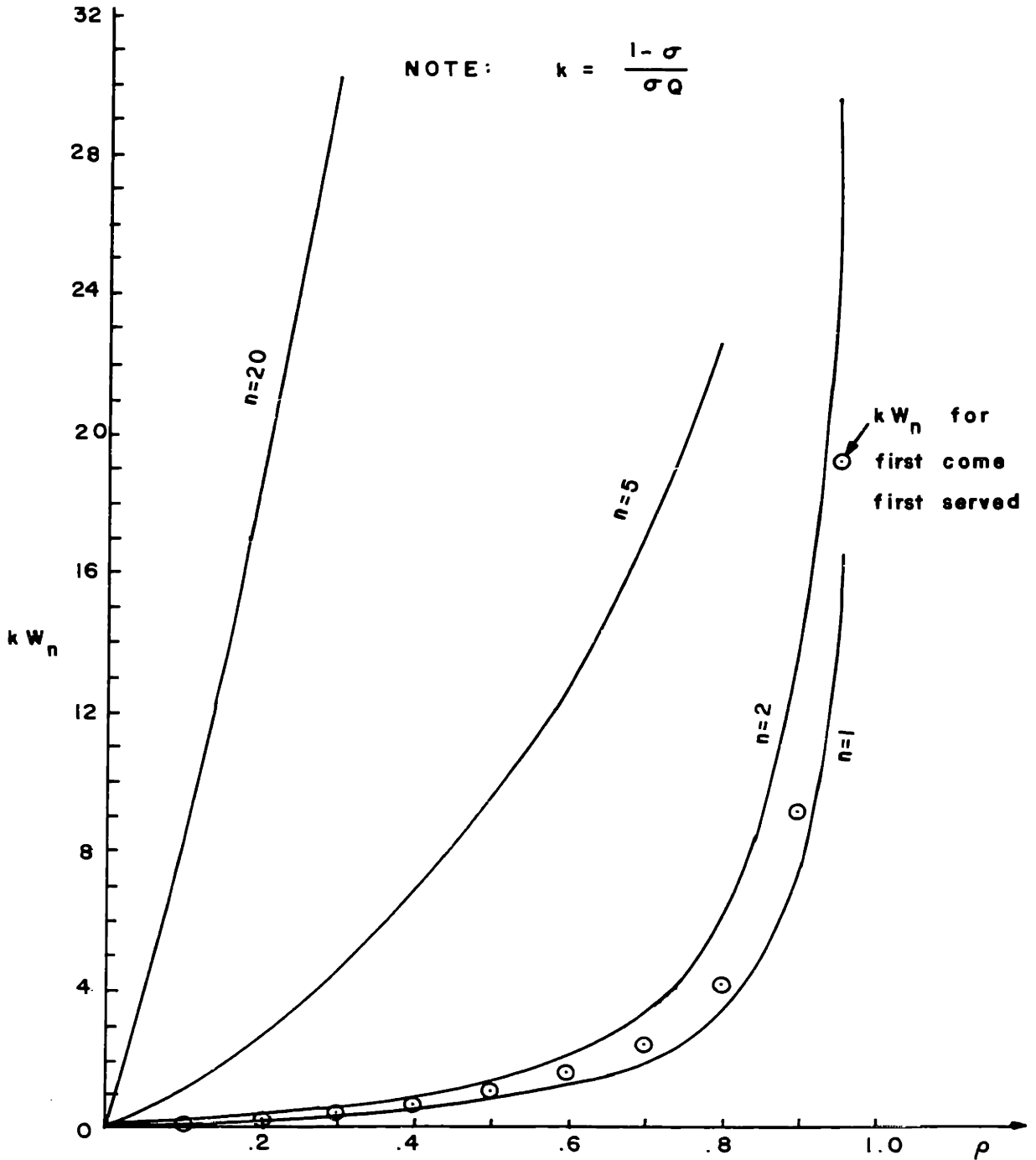

Figure 5.7c $\frac{1-\sigma}{\sigma Q} W_n(\rho)$ for the late-arrival time shared service system
 $\sigma = 1/5$

Eq. 5.17. That is, if we define

$$T_n(\text{FCFS}) \text{ as given by Eq. 5.31}$$

$$T_n(\text{LAS}) \text{ as given by Eq. 5.25}$$

$$T_n(\text{EAS}) \text{ as given by Eq. 5.29}$$

and also

$$W_n(\cdot) = T_n(\cdot) - nQ,$$

then it is a simple algebraic exercise to show that

$$\sum_{n=1}^{\infty} \rho_n W_n(\cdot) = \text{constant} = \frac{Q\rho^2\sigma}{(1-\rho)(1-\sigma)}, \quad (5.35)$$

where

$$\cdot = \{\text{FCFS, LAS, EAS}\}$$

and

$$\rho_n = \rho s_n = \rho(1-\sigma)\sigma^{n-1}$$

Now, since $\lambda_n = \lambda s_n = \lambda(1-\sigma)\sigma^{n-1}$ (the average arrival rate of messages whose length is n service intervals), we see that the mean waiting time (i.e., $\sum_{n=1}^{\infty} \frac{\lambda_n}{\lambda} W_n(\cdot)$) is a constant for the three queue disciplines.

Note that, in all the results of this section, the expected value W_n of the time spent in the queue for a message of length n is obtained from T_n by

$$W_n = T_n - nQ$$

5.4 Conclusions and Extensions

We first discuss some extensions to the material considered in this chapter. Having considered the fixed priority system and the delay dependent priority system separately, it seems a natural extension to consider a combination of these two priority systems. In particular, consider a discipline in which a message from priority group p entering the queue at time T is assigned two numbers: a_p and b_p . The priority $q_p(t)$ at time t associated with that message is calculated as

$$q_p(t) = a_p + (t - T)b_p \quad (5.36)$$

where the range of allowed t is from T up to the time at which this message's service is completed. This priority scheme takes on many interesting and familiar forms in certain special cases*. Of course, when b_p is identically zero, we have the fixed priority system, and when a_p is identically zero, we have the delay dependent priority system.

Because of the importance of the form of Eq. 5.36, a solution for the general case could be very valuable. This has not been accomplished, but an attack on the case of fixed (but nonzero) b_p and variable a_p has been made by Jackson [37]. He considered a model in which time was quantized; during each time interval, a new message arrived with probability λQ , and if the system was nonempty, a completion of service occurred with probability $1 - \sigma$. Among his results are the following bounds on the equilibrium mean waiting time, W_p , for messages with priority number a_p (the notation of his result has been altered to correspond to that used in this report

* For example, a_p and b_p may be chosen so as to describe the following priority disciplines: first come first served, last come first served, random ordering of service, and mixtures of the above.

i.e., the larger the a_p the higher is the priority):

$$W \frac{1-\rho}{P} \leq W_p \leq \frac{W}{P} \frac{1 - \sum_{i=p+1}^P \rho_i}{1 - \sum_{i=p}^P \rho_i} \quad (5.37)$$

where

$$W = \frac{\sigma}{1-\sigma} \frac{\rho}{1-\rho}$$

$$\rho = \frac{\lambda Q}{1-\sigma}$$

and

$$\rho_i = \rho P_r [\text{an entering message is assigned } a_i \text{ as its parameter where } a_i = i]$$

Jackson also goes into some detail for the case of $P=2$ (i.e., only two different priority classes) and derives certain expressions, in matrix notation, for the average waiting times for the two priorities; values for these expressions are tabulated in his appendix [37]. In [38] he derives the asymptotic behavior of the waiting time distribution for this class of dynamic priority queueing models.

Recently, at an informal lecture at M.I.T., John D.C. Little analyzed a very interesting problem associated with priority queueing. He considered the case in which arrivals to the system from the p^{th} group were Poisson at an average rate of λ_p . Associated with such arrivals was a mean service time, $1/\mu_p$, and a cost to the server of C_p dollars for every second that each arrival from the p^{th} group remained in the system (queueing time plus service time). He then solved for that priority discipline which minimized the total time averaged cost to the server. He found that the solution was a fixed priority system in which the highest priority was given to that group with the largest product $\mu_p C_p$. Specifically, he re-ordered the subscripts such that

$$\mu_1 C_1 \leq \mu_2 C_2 \leq \dots \leq \mu_P C_P \quad (5.38)$$

where, again, the larger the subscript, the higher the priority. This is a most interesting result, and worthy of attention.

In reviewing the theorems of this chapter, we find it appropriate to state the important conclusions once again. The first conclusion that we would like to emphasize is the versatility inherent in a delay dependent priority structure. By this we mean that a system designer has at his disposal, a whole set of parameters (the set b_p) with which he can adjust the relative waiting times, W_p . He must have this freedom if he intends to satisfy, or come close to satisfying, a set of specifications given him by the intended user of the system. In general, the user will specify the traffic to be handled; i.e., he will specify the number P , of priority groups, the average arrival rate λ_p and average message length $1/\mu_p$ for each of these groups*. Then the user will specify a set of relative W_p that he desires from the system. The additional number of degrees of freedom that the designer has from the set b_p is just what is necessary to satisfy the user's demands. Without this freedom (as in the fixed priority system), the set W_p is fully determined, and the designer cannot alter their relative values. Even with the b_p , certain limitations exist. First, the function W_p can not lie below W_p for the fixed priority system since in the fixed priority system, the P^{th} group is given complete priority over all other groups, and members from this group interfere only with each other. Secondly, the conservation law clearly puts a constraint on the absolute values of the set W_p .

The conservation law, although proven for the class described in this chapter, probably holds for a more inclusive class as well. Indeed, we have seen the case of a

* Note that after λ_p and $1/\mu_p$ are specified, then $\rho = \sum_{p=1}^P \lambda_p / \mu_p$ is also specified.

queue discipline (the time-shared service system) which falls outside our defined class, and which nevertheless obeys the conservation law. At least two interesting conclusions can be drawn from the conservation law. Firstly, if all $\mu_p = \mu$, then the law says that a meaningful average* of the average waiting times is invariant to a change in queue discipline. Therefore, one need not search for a special queue discipline in the class to minimize this average - it is fixed. Secondly, if the μ_p are arbitrary, then the time averaged** waiting time is invariant to a change in the queue discipline.

Finally, we would like to refer the reader to Chapter VII in which is described the results of certain simulation experiments. These experiments demonstrate that the conservation law holds for a fixed priority system in a communication network for the case in which $\mu_p = \mu$. We tabulate these results in Table 5.1 below.

$\gamma/\mu C$	Traffic Matrix	μCT					
		Identical Capacity		Proportional Capacity		Square Root Capacity	
		P=1	P=3	P=1	P=3	P=1	P=3
.0625	τ_1	49.6	49.2	48.4	47.6	37.3	37.2
.0625	τ_3	49.6	50.4	51.2	50.8	50.0	50.8
.250	τ_1	503.	490.	73.5	73.8	61.2	61.2
.250	τ_3	84.5	82.7	87.3	85.2	86.0	82.8
.376	τ_1	-	-	103.	111.	100.	92.
.376	τ_3	154.	159.	151.	153.	144.	154.

Table 5.1 Values of μCT for the star net obtained from simulation, demonstrating[†] experimental evidence of the conservation law.

* This average weights the waiting time by the relative number of messages which must suffer that waiting time.

** See footnote on page 105.

† The value of P, as before, gives the number of priority groups for the fixed priority system which was simulated. C refers to the total capacity assigned to the net. For the definition of other terms in the table, the reader is referred to Chapter VII.

CHAPTER VI

RANDOM ROUTING PROCEDURES

A random routing procedure refers to those decision rules in which the choice for the next node to visit is made according to some probability distribution over the set of neighboring nodes*. In this chapter, we connect a group of nodes together and apply a random routing procedure to the resultant net. Two results of interest emerge from this investigation. First, we find that for a particular class of random routing procedures, we are able to solve for the expected number of steps that a message must take before arriving at its destination. Second, we derive an expression for the expected time that a message spends in the net. In the analysis, we use our model with the inclusion of the Independence Assumption (see Chap. III). A number of results tangent to the main discussion may be found in Appendix D.

One may reasonably ask why random routing procedures are of interest. Their main advantage is that they are simple, both in conception and in realization in a practical system. Another advantage is that systems operating under a random routing procedure are relatively insensitive to changes in the structure of the network; that is, if some of the channels disappear, then the routing procedure continues to function without considerable degradation in performance. Moreover, since the random routing procedure does not make use of directory information, changes in the network structure need not be made known to all the nodes. This fact becomes increasingly important in a hostile or fluid environment in which changes in the

*For example, one random routing procedure may be defined such that the next node to visit is chosen uniformly over the set of idle channels leading out of the present node.

network take place continuously. If it were necessary to transmit information around the network informing all nodes of each change, the network might easily become flooded with directory information alone and leave no transmission capability for message traffic. Furthermore, it may be added that random routing procedures offer an example of one of the few routing procedures in which it is possible to get some meaningful analytic results. Thus, these procedures may well serve as a measure of the quality of performance of other routing procedures.

Clearly, there are a number of inherent disadvantages to random routing procedures. The major difficulty is that the routing procedure does not take advantage of certain available information. In particular, the topology of the network along with the destination of a message suggest that certain paths are to be preferred over others; the random routing procedure neither recognizes nor utilizes this information. As a result, messages are forced to follow a random path. When finally a message is fortunate enough to be transmitted to its destination, it is dropped from the network. In 1960, R. Prosser [24] offered an approximate analysis of a random routing procedure in a communication net in which he showed that such procedures are highly inefficient in terms of message delay, but extremely stable (i. e., they are relatively unaffected by small changes in the network structure).

The overall effect of random routing is to increase the internal traffic that the network is required to handle; consequently, the external traffic that may be applied to the net is greatly reduced. In addition, the time that a message spends in the network is increased, thus reducing the grade of service to the user of the system.

6.1 Markov Model - Circulant Transition Matrices

The two quantities of most interest to the user in the study of any routing procedure are the expected time, T , that a message spends in the net, and the mean total traffic that the network can handle. In the following discussion, we center our interest on the first of these (T), and, as we shall see, this analysis yields an answer for the mean total traffic as well.

The time that a message spends in the system is made up of the sum of the time spent at each node that the message visits. If it turns out that the expected time, $T(n)$, spent at node n is approximately the same value, T_0 for all n , then it is clear that

$$T = \bar{n} T_0 \quad (6.1)$$

where \bar{n} is the average number of steps* that a message must take to reach its destination.

In the case of random routing procedures, the calculation of \bar{n} may be carried out independently of the calculation of T_0 , whereas the converse is not necessarily true. We therefore concentrate upon the calculation of \bar{n} initially. Note that this approach effectively removes from consideration, all questions of queueing and leaves only the matter of topology and routing. We return to the queueing aspect of the problem in Sect. 6.4 .

*The average number of nodes visited is $\bar{n}+1$ but the last node visited is the destination itself, and by convention, we agree that once the destination is reached, the message is immediately dropped from the net. The quantity of interest is therefore the average number of steps taken (also referred to as the average path length).

The model that we choose to represent the random routing procedure is that of a Markov process with $N+1$ states. Each node in the network corresponds to a distinct state, where the nodes are numbered $0, 1, 2, \dots, N$. Associated with each message is an originating node and a destination. The node of origination will be the initial position of the message in the process, and the destination will be the absorbing node for this message. The routing procedure is reflected in the Markov model as the one-step transition probability matrix P . A typical entry, p_{ij} in this matrix is then the probability that a message in node i will be transmitted to node j next*, where, as usual, we require that $p_{ij} \geq 0$. The matrix P , together with the a-priori distribution of the originating node, completely describe the Markov process**.

The analytic solution for \bar{n} for an arbitrary matrix P cannot in general be obtained in closed form. A number of different expressions for \bar{n} which involve infinite summations are well-known, and are summarized in Appendix D. These open forms are of limited utility for analytic work. In order to obtain a closed form solution, one must put some structure into the matrix P . The added structure should not be such that the resultant solution, although elegant and concise, is of no use to the problem at hand.

Thus, we find ourselves in the position of defining a restricted class of Markov processes (i. e., P matrices) which are analytically tractable, and at the same time useful in answering questions about interesting random routing procedures.

*Of course, this probability is conditioned on the fact that the destination for this message was not node i itself.

**Furthermore, the network topology, or connectivity, is implicitly described by the P matrix; that is, channels exist only between those nodes i, j for which $p_{ij} > 0$.

As it turns out, there is a subclass of Markov processes which includes a large number of very interesting random routing procedures and which at the same time, yields to analysis. The set of Markov processes included in this class is defined to be those whose P matrix is of the following form:

$$P = \begin{bmatrix} q_0 & q_1 & q_2 & \cdot & \cdot & \cdot & q_N \\ q_N & q_0 & q_1 & \cdot & \cdot & \cdot & q_{N-1} \\ q_{N-1} & q_N & q_0 & \cdot & \cdot & \cdot & q_{N-2} \\ \cdot & \cdot & \cdot & & & & \cdot \\ \cdot & \cdot & \cdot & & & & \cdot \\ \cdot & \cdot & \cdot & & & & \cdot \\ q_1 & q_2 & q_3 & \cdot & \cdot & \cdot & q_0 \end{bmatrix} \quad (6.2)$$

This particular form of transition matrix is known as a circulant matrix, and it describes a class of Markov processes referred to as cyclical random walks. As in any probability transition matrix, each row must sum to unity; in this case, that constraint may be expressed as

$$\sum_{i=0}^N q_i = 1$$

Furthermore, we require that the Markov chain described by P in Eq. 6.2 is irreducible* (i. e., each state can be reached from all other states).

*See Feller [13 Sect. XV.4 .]

Note that each row of this matrix is the same as the row above it except for a rotation of one place to the right. One major feature of this matrix is that no matter which node (row) one chooses, the remainder of the net (matrix) appears identical, i. e., looking out into the rest of the net, each node sees the same topological structure.

In summary then, we consider those random routing procedures which are describable by finite irreducible Markov processes whose probability transition matrix is a circulant matrix, i. e., routing procedures which are cyclical random walks over the space of nodes (communication centers).

6.2 The Average Path Length

As shown in Appendix D, the cyclical random walk yields the following expression for the expected number of steps, \bar{n}_i , required to travel from node i to node N . Notice that the choice of node N as the destination for each message is in no way restrictive since the choice of i is arbitrary and because the entries in the matrix can easily be relabeled.

THEOREM 6.1

The average path length, \bar{n}_i , from node i to node N for any finite dimensional irreducible Markov process whose probability transition matrix is a circulant matrix (see Eq. 6.2), is

$$\bar{n}_i = \sum_{r=1}^N \frac{1 - \theta^{r(i+1)}}{1 - \sum_{s=0}^N q_s \theta^{sr}} \quad (6.3)$$

where $i = 0, 1, 2, \dots, N$, and where θ is the $(N + 1)^{\text{th}}$ primitive root of unity, i. e.,

$$\theta = e^{2\pi j/(N+1)} \quad (6.4)$$

and where

$$j = \sqrt{-1} \quad .$$

This result is rather simple, and is easily evaluated for any choice of the set $q_s (s = 0, 1, 2, \dots, N)$. In addition, the generating function* $F_{iN}(t)$ for the first passage time from node i to node N takes on the form

$$F_{in}(t) = \frac{1 + (1-t) \sum_{r=1}^N \frac{\theta^{r(i-N)}}{N} \frac{1}{1 - t \sum_{s=0}^N q_s \theta^{sr}}}{1 + (1-t) \sum_{r=1}^N \frac{1}{N} \frac{1}{1 - t \sum_{s=0}^N q_s \theta^{sr}}} \quad (6.5)$$

From the result for \bar{n}_i , one may ask about the behavior of cyclical random walks when certain averages are taken over the index i (which represents the originating node in the model). The simplest assumption to make is that the a-priori probability of starting a message in any node is uniform over the set of possible nodes ($i = 0, 1, 2, \dots, N-1$), where we clearly do now allow a message to originate

*See Appendix D for the definition of generating function.

at its destination. In this case, we define \bar{n} to be the average over i , of the number of steps required to reach the destination, and obtain the following result (as shown in Appendix D):

$$\bar{n} = \frac{1}{N} \sum_{i=0}^N \bar{n}_i = \frac{N+1}{N} \sum_{r=1}^N \frac{1}{1 - \sum_{s=0}^r q_s \theta^{sr}} \quad (6.6)$$

We digress, for a moment, to consider an interesting and different assumption which may be made about the a-priori distribution of originating node. In particular, let us assume that the probability of starting a message in node i is equal to q_{i+1} for $i=0, 1, \dots, N-1$ and for consistency, we allow a message to originate in node N with probability q_0 . Defining \bar{n}' as the result of this averaging process, we find*

$$\bar{n}' = \sum_{i=0}^{N-1} q_{i+1} \bar{n}_i + q_0 \bar{n}_N = N \quad (6.7)$$

This result is surprisingly simple. It states that if one chooses to originate messages over the set of nodes in the manner just described, then, no matter what the actual choice of the set q_i is (subject to the finiteness and irreducibility of P), the average number of steps to reach node N (the destination) turns out to be N^{**} .

*See Appendix D for proof.

**Prof. C. E. Shannon, in a private discussion, has given a very nice explanation for the simplicity of this result. Essentially, his comment was that since each node in the network is equivalent, the average number of steps required to return to a node must be $N+1$ (the number of nodes in the system). Now, if we assume that we begin at node N (the destination), and make one step out into the network, we find ourselves at node i with probability q_{i+1} and at node N with probability q_0 , which is just the set of probabilities described above. Since we have already taken one step, the average number of steps left to return to node N must now be $(N+1)-1$ which is merely N (as stated by Eq. 6.7).

6.3 Examples of Networks Included by the Model

Some of the most commonly considered network configurations are included by our model of a cyclical random walk. In the first place, the well-known ring configuration corresponds to a matrix P and a topological diagram as shown in Fig. 6.1.

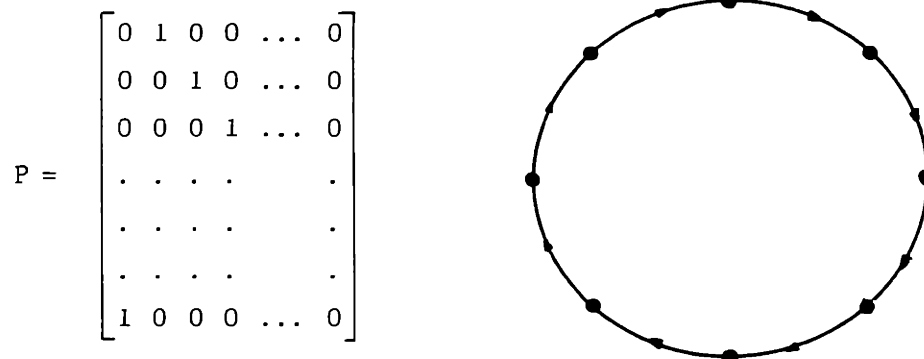

Figure 6.1 The Ring Net Configuration

Further, the nearest neighbor configuration is included, and corresponds to the matrix P and the diagram shown in Fig. 6.2.

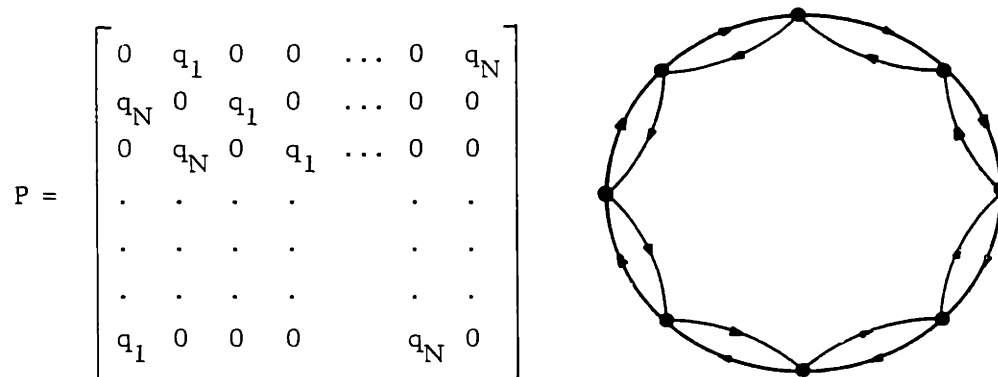

Figure 6.2 The Nearest Neighbor Configuration

Let us now consider a more general type of nearest neighbor configuration which is included in our model, namely, one in which an arbitrary set of links emanates

from each node (the same set for each node), an example of which is shown in Fig. 6.3*.

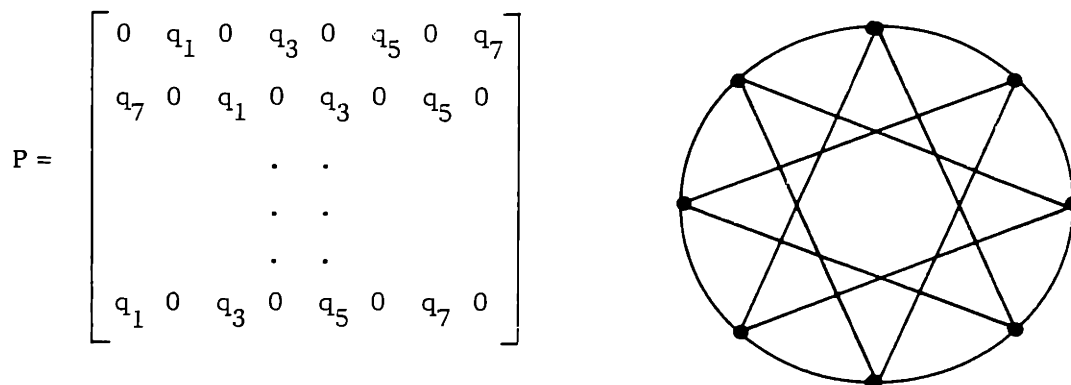

Figure 6.3 A More General Nearest Neighbor Configuration

The fully connected configuration with uniform probabilities is a network of considerable interest, and is also included by the model, as shown in Fig. 6.4.

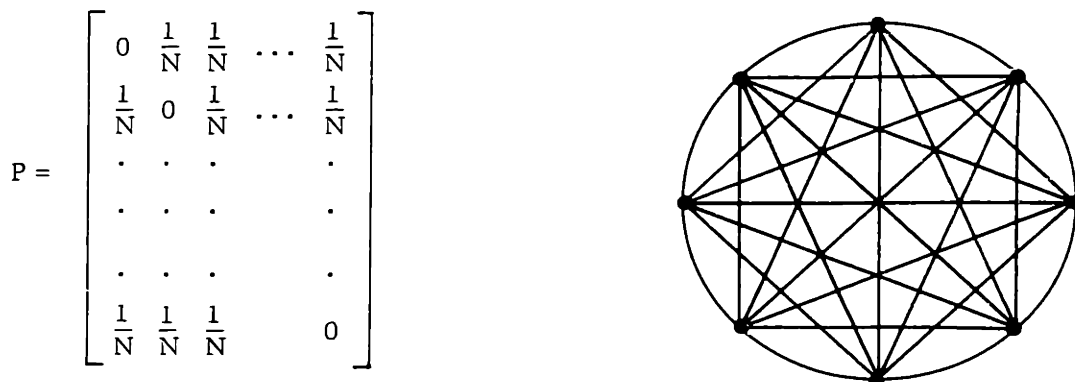

Figure 6.4 The Fully Connected Net

Clearly, one could go on and describe many more interesting configurations included by our model. It suffices to say that the restriction to a cyclical random

* An undirected link indicates a two-way connection.

walk is not a very severe one.

6.4 The K-Connected Communication Network

Having solved for \bar{n} , let us now consider the dynamics of the interaction of many messages in a network with random routing, (i.e., let us consider the queueing problems that arise). We mention first, that Theorem D.1 in Appendix D states that in general, an arbitrary transition probability matrix is not allowed if we insist that no channels be idle when there is any message in the queue awaiting service. The corollary to that theorem, however, does permit a particular choice of transition probabilities, namely, a uniform distribution over the set of channels emanating from each node. Once again, we require the use of the Independence Assumption in the analysis.

We are now ready to define the K-connected network as follows:

- a) $N+1$ nodes
- b) Poisson message arrival statistics at an average rate of $\gamma/(N+1)$ messages per second from external sources into each node.
- c) Message lengths are exponentially distributed with mean length $1/\mu$ bits per message, and are freshly chosen each time a message enters a node (the Independence Assumption).
- d) The probability that node k is the destination for a message which originated in node j is equal to $1/N$ for all $k \neq j$.
- e) The probability transition matrix P is an irreducible circulant matrix with exactly K non-zero entries in each row, each such entry being of value $1/K$ with all diagonal terms equal to 0. Clearly, this implies that there are K channels leaving and K channels entering each node.
- f) The channel capacity of each channel in the net is equal to $C/K(N+1)$. Thus, the total channel capacity of the net is C .

We note that items b and d imply that the traffic matrix is a uniform traffic matrix with each off-diagonal entry equal to $\gamma/K(N+1)$. Clearly, with these definitions, all nodes behave in the same way statistically. Accordingly, let P_n be the probability that there are n messages in a particular node (any node is representative of all nodes) in the steady state. We then state*

THEOREM 6.2**

For the K -connected net,

$$P_n = \begin{cases} P_0 \frac{(\bar{n}\rho)^n K^n}{n!} & n = 0, 1, 2, \dots, K \\ P_0 \frac{(\bar{n}\rho)^n K^K}{K!} & n \geq K \end{cases} \quad (6.8)$$

provided $\bar{n}\rho < 1$, where

$$\rho = \gamma/\mu C \quad (6.9)$$

$$P_0 = \left[\sum_{n=0}^{K-1} \frac{(K\bar{n}\rho)^n}{n!} + \frac{(K\bar{n}\rho)^K}{(1-\bar{n}\rho)K!} \right]^{-1} \quad (6.10)$$

$$\bar{n} = \frac{N+1}{N} \sum_{r=1}^N \frac{1}{1 - \frac{1}{K} \sum_{s \in S} \theta^{sr}} \quad (6.11)$$

*This theorem is similar to one published by Jackson [23]. The difference is that we have introduced the notion of a destination, and we also have an explicit expression for the geometric decay factor $\bar{n}\rho$.

**See Appendix D for proof of this theorem.

$$\theta = e^{2\pi j/(N+1)} = (N+1)^{\text{th}} \text{ primitive root of unity.} \quad (6.12)$$

S = the set of integers which corresponds to the position of the elements of the first row of P which are non-zero.

Note that P_n in the K-connected net behaves very much like P_n in the multiple channel system (see Eq. A. 9); the only difference is the introduction of \bar{n} .

Further, we can solve for T, the expected time that a message spends in the network (as defined in Sect. 6.1):

THEOREM 6.3*

For the K-connected net,

$$T = \frac{(N+1)K\bar{n}}{\mu C} + \frac{\bar{n}(N+1)}{\mu C(1-\bar{n}\rho)} \left[\frac{1}{(1-\bar{n}\rho) S_K + 1} \right] \quad (6.13)$$

where

$$S_K = \sum_{n=0}^{K-1} (K\bar{n}\rho)^{n-K} K! / n! \quad (6.14)$$

and ρ and \bar{n} are defined in Theorem 6.2.

The first term in the expression for T is merely the expected time that a message spends in transmission between nodes, and the second term is the expected time that a message spends waiting on queues as it passes through the net.

In Sect. 6.1, it was stated that the mean total traffic that the network could handle would be found in the course of our investigation of T. Indeed this is so,

*See Appendix D for proof of this theorem.

as can be seen by examining Theorem 6.2. The condition $\bar{n}\rho < 1$ is merely a statement that the mean total traffic that can be accepted at each node from external sources must be less than $C/\bar{n}(N+1)$ bits per second.

6.5 Conclusions

Certain aspects of a class of random routing procedures have been investigated in this chapter. One of the main results was to solve for \bar{n} , the expected number of steps that a message takes in a network incorporating a random routing procedure which is describable by a finite dimensional irreducible circulant transition matrix. This includes a large number of interesting random routing procedures. For such nets, we find that

$$\bar{n} = \frac{N+1}{N} \sum_{r=1}^N \frac{1}{1 - \sum_{s=0}^{r-1} q_s \theta^{sr}} \quad (6.6)$$

Furthermore, we found that if we restrict our class of nets to K -connected networks in which we also introduce the Independence Assumption, then T , the expected time that a message spends in the net is

$$T = \frac{(N+1)K\bar{n}}{\mu C} + \frac{\bar{n}(N+1)}{\mu C(1 - \bar{n}\rho)} \left[\frac{1}{(1 - \bar{n}\rho)S_{K+1}} \right] \quad (6.13)$$

We are now in a position to evaluate the performance of a random routing procedure. Specifically, Table 6.1 gives the value of \bar{n} for the K -connected net of 13 nodes at four* different values of K . Two sets of numbers are presented:

* We do not include $K = 1$ since this defines the ring net, which is not truly a net with random routing.

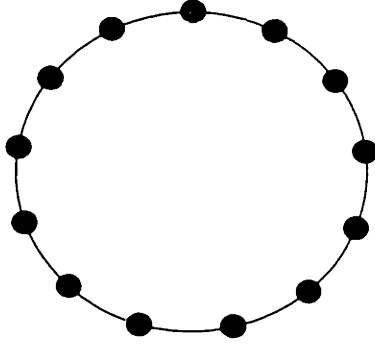
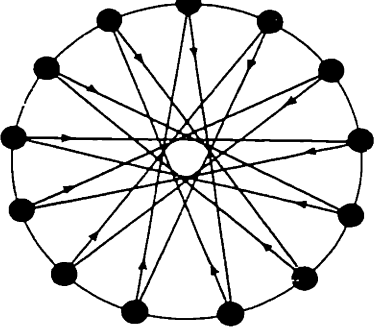
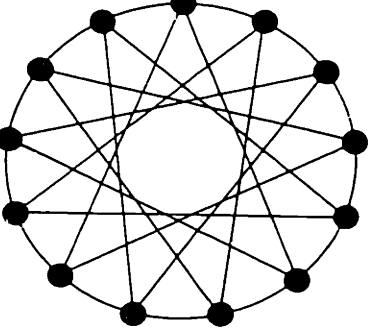
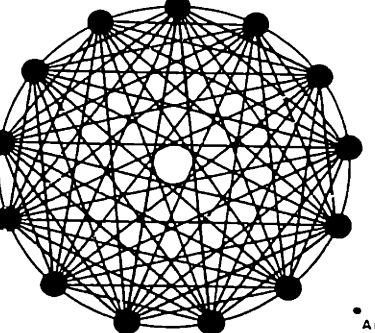
K	NET*	\bar{n} FOR RANDOM ROUTING	\bar{n} FOR THE SET OF SHORTEST PATHS
2		30.3	3.5
3		14.65	2.25
4		14.0	1.67
12		12.0	1.0

* AN UNDIRECTED LINK INDICATES A TWO-WAY CONNECTION

TABLE 6.1 AVERAGE NUMBER OF STEPS FOR RANDOM ROUTING AND FOR THE SET OF SHORTEST PATHS IN THE K-CONNECTED NET

the first set represents \bar{n} for the case of random routing; and the second set gives \bar{n} for the set of shortest paths in the same network. As stated in the introductory remarks to this chapter, we see that the number of nodes visited by each message is considerably larger for random routing procedures as compared to simple fixed routing procedures.* Furthermore, since the maximum traffic that can be handled is on the order of $C/\bar{n}(N+1)$ bits per second, and since \bar{n} is excessively large, we verify that random routing also reduces the total traffic that a net can sustain.

A digital simulation** was run for the K-connected net with $K = 4$, and $N + 1 = 13$, for a number of different traffic loads. The routing procedure was fixed, and the quantity measured was T , the average time spent in the net. Table 6.2 presents the results of this experiment along with the calculated results for random routing from Eq. 6.13. Both sets of numbers are for identical externally applied traffic statistics. It is immediately obvious from this table that random routing procedures are extremely costly in terms of message delay.

*By a fixed routing procedure, we mean that given a message's origin and destination, there exists a unique path through the net which this message must follow.

**See Appendix E for a description of the simulation program.

$\rho = \gamma/\mu C$	μCT for Random Routing	μCT for Fixed Routing
1/128	728	87.8
1/64	731	88.4
1/32	774	93.7
1/16	1803	102.
1/8	network overloaded	120.
1/4	network overloaded	173.
1/2	network overloaded	580.

Table 6.2 Values of μCT for Random Routing (calculated) and for Fixed Routing (simulation) in a K-Connected Net Where $K = 4$.

In summary, the price that one pays for random routing is threefold: the number of nodes visited by each message is large; the time spent at each node is large; and the mean total traffic that the network can accept is small (all of these comments are relative to a fixed routing procedure which is described in Chapter VII). The advantages are that the procedures of random routing are simple, require little information about the rest of the network, and degrade slowly in the presence of a hostile or fluid environment.

CHAPTER VII

SIMULATION OF COMMUNICATION NETS

This chapter describes the results obtained from a communication net simulation program. The simulation runs were made on Lincoln Laboratory's TX-2 high speed digital computer [39]. The purpose of the simulation was to experimentally test the results and predictions obtained from our theoretical investigation. Furthermore, as anticipated, the results of experimentation suggested new lines of study. Thus, the simulation served a three-fold function: first, it offered a means of verification for theoretically obtained results; second, it allowed experimentation in areas where the mathematical theory was unmanageable;* and third, it acted as a feedback mechanism by suggesting new ideas.

An operational description of the simulation program may be found in Appendix E. In Sect. 7.1, we describe the nets that were simulated. Furthermore, the specific form of alternate routing used is also defined in that section. The results of our experimentation are presented graphically in Sect. 7.2. The three quantities of interest in the experimentation were: the effect of network topology, channel capacity assignment, and alternate routing on the average message delay. In Sect. 7.3, we present two theorems related to the effects and design of alternate routing procedures.

7.1 Specific Network Descriptions

In Appendix E we list the type data required to specify a communication net. This section presents some specific data which define the nets that were simulated. To achieve this end, we must describe the format in which the data is presented. In particular, we define an incidence matrix I in which an entry of unity in the ij position

* It also allowed us to test the validity of the Independence Assumption.

indicates the presence of a channel leading from node i to node j ($i, j, = 1, 2, \dots, N$) and the absence of an entry indicates the absence of that channel. Note that the matrix I therefore defines the topological structure of the net. The exact channel capacity assigned to each channel need not be specified since, if desired, the program will automatically allocate capacity according to one of three assignments: square root, proportional, or identical capacities.* Of course, the total capacity assigned to the entire net must be specified separately.

The traffic matrix τ , is defined such that an entry in the ij position gives the relative traffic which has node i as origin and node j as destination. The total traffic, γ , must be given separately, and defines the average number of messages entering the network per second.

Furthermore, the routing procedure must be specified. We choose first to define a specific form of alternate routing procedure; we then define a special case of alternate routing as fixed routing. Our alternate routing procedure is defined to be a decision rule which operates on a set of lists as follows. Given that a message is now in node i , and has, for a final destination, node j , the decision rule consults the ij^{th} list in order to decide which node the message will next visit. The message is routed to the first node entered on this list if the transmission channel connecting node i to this node is currently idle; if this channel is busy, the second entry on the list is tried, etc., until the list is exhausted, in which case, the message must wait on a queue in node i until a transmission channel connected to any node on the list becomes available at node i .**

* Hereafter, the capacity assignment described by Eq. 4.7 is referred to as the square root assignment; the assignment according to Eq. E.1 (namely, $C_i = \lambda_i C/\lambda$) is referred to as the proportional assignment; and the capacity assignment wherein all capacities are equal (namely, $C_i = C/n_c$ where n_c denotes the number of channels in the net) is referred to as the identical capacity assignment.

** This corresponds to continually searching the list.

Clearly, this form of routing procedure offers many choices at each step; the lists express one's preference of one path over another. Indeed, this is a simple system which offers alternate routes under busy conditions. It is convenient to write this set of lists in the form of a matrix, R , the ij^{th} entry being a list of numbers such that the first number (the preferred path) is the leftmost entry in this position, and the rightmost number is the least desired acceptable path.

We now define a fixed routing procedure as the special case of alternate routing in which each list contains exactly one entry. Clearly, this procedure defines a unique path through the net for any origin-destination pair.

We consider four topologically different nets, each consisting of 13 nodes. The values of γ, μ , and C are left unspecified, and are adjusted in the actual simulation so as to achieve a range of traffic loads (ρ) imposed on the net. Furthermore, we define three relative traffic matrices τ_1, τ_2 , and τ_3 as follows:

		Destination node												
		1	2	3	4	5	6	7	8	9	10	11	12	13
Node of origination	1	0	1	4	1	1	9	36	9	1	1	4	1	100
	2	1	0	4	1	1	4	1	1	1	1	1	0	1
	3	4	4	0	4	9	4	4	4	9	1	1	1	4
	4	1	1	4	0	1	1	1	4	1	0	1	1	1
	5	1	1	9	1	0	4	36	4	100	1	9	1	1
	6	9	4	4	1	4	0	4	1	4	4	4	1	9
	7	36	1	4	1	36	4	0	4	36	1	4	1	36
	8	9	1	4	4	4	1	4	0	4	1	4	4	9
	9	1	1	9	1	100	4	36	4	0	1	9	1	1
	10	1	1	1	0	1	4	1	1	1	0	4	1	1
	11	4	1	1	1	9	4	4	4	9	4	0	4	4
	12	1	0	1	1	1	1	1	4	1	1	4	0	1
	13	100	1	4	1	1	9	36	9	1	1	4	1	0

The absence of an entry in any matrix is taken to be an entry of zero.

The first net we define is the diamond net. Its topological structure, its incidence matrix I_d , and the matrix R_{d1} (which defines its complete alternate routing procedure) are shown in Fig. 7.1. In all diagrams of network topology, the absence of an arrow on a channel indicates two independent one-way channels. The fixed routing procedure for the diamond net defined by the matrix R_{d4} , is shown in Fig. 7.2. As may be noted, the entries in R_{d4} correspond to the leftmost entries in R_{d1} . Also in Fig. 7.2 are shown two other matrices R_{d2} and R_{d3} which describe other forms of alternate routing. In particular, R_{d3} allows the same alternate routing for messages destined for node 13 as does R_{d1} ; however, messages destined for any other node in the net follow the fixed routing procedure of R_{d4} . Further, R_{d2} allows the full alternate routing only for messages in node i which are destined for node j , where the permitted values of the pair ij are: 13, 1; 9, 5; 5, 9; 1, 13. For other values of the pair ij , fixed routing is used. The motivation for defining these four routing procedures is to introduce varying degrees of alternate routing in the net. Specifically, if we consider the traffic matrix τ_1 , we see that the heavy traffic flow is between the four origin-destination pairs listed for R_{d2} . Thus, for τ_1 , R_{d4} represents no alternate routing (this is true for any τ_i), R_{d3} represents a small degree of alternate routing, R_{d2} represents a greater degree of alternate routing, and R_{d1} represents the largest degree of alternate routing that we consider.

We next present the K-connected net as defined in Fig. 7.3. This net corresponds to the K-connected net studied in Chapter VI with $K=4$. Note that only a fixed routing procedure R_K has been defined for this net.

$I_d =$

	1	2	3	4	5	6	7	8	9	10	11	12	13
1			1	1	1								
2	1				1								
3	1	1		1	1								
4	1		1				1	1					
5					1					1			
6		1	1	1		1					1	1	
7			1			1		1			1		
8			1	1	1		1		1		1	1	
9					1			1				1	
10						1	1			1		1	1
11						1	1	1			1	1	1
12								1	1		1	1	1
13											1	1	1

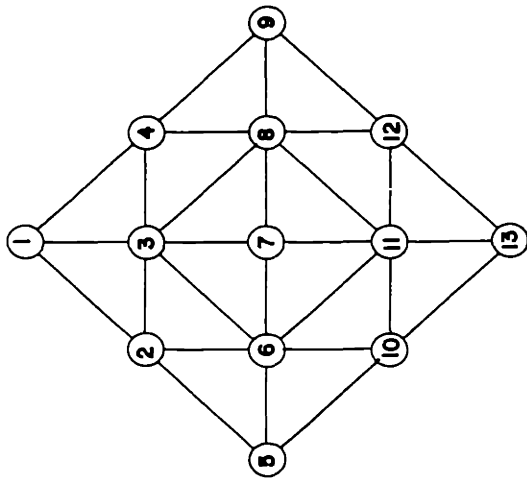

$R_{dl} =$

	1	2	3	4	5	6	7	8	9	10	11	12	13
1													
2	1	3											
3	1	2	4										
4	1	3	8	1	3	1							
5	2	6	2	6									
6	2	3	5	3	2								
7	3	6	8	3	6	1	3						
8	4	3	3	4	3	9	7	3	1				
9	4	8	4	8	4	12	8	4	12				
10	6	5	6	1	5	6	6	1	1	1			
11	7	8	6	10	7	8	6	8	12	12	8		
12	8	9	11	8	11	8	11	9	9	8	11	8	13
13	11	12	10	11	10	11	10	11	10	11	10	11	12

Figure 7.1 The diamond net with its incidence matrix and its complete alternate routing procedure

	1	2	3	4	5	6	7	8	9	10	11	12	13
1													3 2 4
2													6 5
3													7 6 8
4													8 9
5													10 6
6													10 11
7													11 8 6
8													12 11
9													12 8
10													13 11
11													13 12 10
12													13 11
13													

$$R_{d3} =$$

	1	2	3	4	5	6	7	8	9	10	11	12	13
1		2	3	4	2	2	3	4	4	2	3	4	3
2		1	3	3	5	6	3	3	3	6	6	3	6
3		1	2	4	2	6	7	8	4	6	3	8	7
4		1	3	3	3	8	8	9	8	8	8	8	8
5		2	2	2	6	6	6	6	6	10	10	10	10
6		2	2	3	3	5	7	7	7	10	11	11	10
7		3	3	3	8	6	6	8	8	6	11	11	11
8		4	3	3	4	7	7	7	9	11	11	12	12
9		4	4	4	8	8	8	8	12	12	12	12	12
10		6	6	6	6	5	6	6	11	11	11	11	13
11		7	6	7	8	10	6	7	8	12	10	12	13
12		8	11	8	8	11	11	11	8	9	11	11	13
13		11	10	11	12	10	10	11	12	12	10	11	12

$$R_{d4} =$$

	1	2	3	4	5	6	7	8	9	10	11	12	13
1													3 2 4
2													
3													
4													
5									6 10 2				
6													
7													
8													
9													
10													
11													
12													
13													

Figure 7.2 Other routine procedures for the diamond net

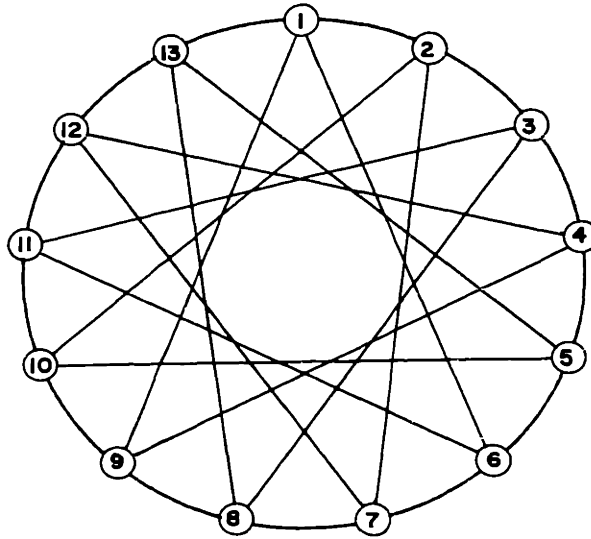

$$I_K =$$

	1	2	3	4	5	6	7	8	9	10	11	12	13
1		1				1			1				1
2	1		1				1			1			
3		1		1				1			1		
4			1		1				1			1	
5				1		1				1			1
6	1				1		1				1		
7		1				1		1				1	
8			1				1		1				1
9	1			1				1		1			
10		1			1				1		1		
11			1			1				1		1	
12				1			1				1		1
13	1				1			1				1	

$$R_K =$$

	1	2	3	4	5	6	7	8	9	10	11	12	13
1		2	2	2	6	6	6	9	9	9	13	13	13
2	1		3	3	3	7	7	7	10	10	10	1	1
3	2	2		4	4	4	8	8	8	11	11	11	2
4	3	3	3		5	5	5	9	9	9	12	12	12
5	13	4	4	4		6	6	6	10	10	10	13	13
6	1	1	5	5	5		7	7	7	11	11	11	1
7	2	2	2	6	6	6		8	8	8	12	12	12
8	13	3	3	3	7	7	7		9	9	9	13	13
9	1	1	4	4	4	8	8	8		10	10	10	1
10	2	2	2	5	5	5	9	9	9		11	11	11
11	12	3	3	3	6	6	6	10	10	10		12	12
12	13	13	4	4	4	7	7	7	11	11	11		13
13	1	1	1	5	5	5	8	8	8	12	12	12	

Figure 7.3 The K-connected net (K=4)

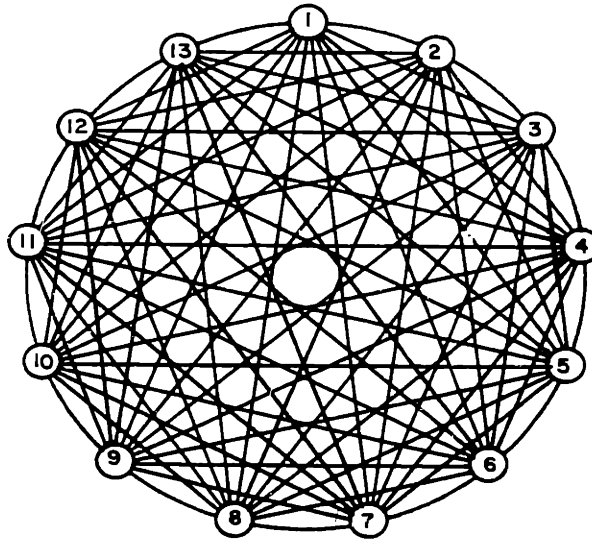

Figure 7.4 The fully connected net

Another net of interest is the fully connected net which is defined in Fig. 7.4. The incidence matrix, I_F , for this net contains an entry of unity in each off-diagonal position, and an entry of zero in each main diagonal position. In Fig. 7.5 we define for the fully connected net, an alternate routing matrix $R_F(n)$ for $n = 1, 2, \dots, 6$. The value of n is meant to indicate the number of alternatives to be included in each ij position of the matrix. Thus, Fig. 7.5 displays $R_F(6)$; $R_F(n)$ for $n < 6$ is merely the same as $R_F(6)$ with the last $6-n$ entries deleted from each position. Clearly, $R_F(1)$ is the fixed routing procedure for this net. In order to fit Fig. 7.5 on one page, we have found it convenient to use a different method for recording each list. Specifically, we have broken the list of six numbers into two lines of three numbers each, in such a way that the entry $(1, 2, 3, 4, 5, 6)$ becomes $\begin{pmatrix} 1, 2, 3 \\ 4, 5, 6 \end{pmatrix}$. One notes that the fully connected net is identical to the K -connected net where K equals N .

Lastly, we present the star net which is defined in Fig. 7.6. Note that for this net, we define only a fixed routing procedure.

	2 3 4	3 4 5	4 5 6	5 6 7	6 7 8	7 8 9	8 9 10	9 10 11	10 11 12	11 12 13	12 13 14	13 14 15	14 15 16
1 3 4		3 4 5	4 5 6	5 6 7	6 7 8	7 8 9	8 9 10	9 10 11	10 11 12	11 12 13	12 13 14	13 14 15	14 15 16
5 6 7		6 7 8	7 8 9	8 9 10	9 10 11	10 11 12	11 12 13	12 13 14	13 14 15	14 15 16	15 16 17	16 17 18	17 18 19
1 2 4	2 4 5		4 5 6	5 6 7	6 7 8	7 8 9	8 9 10	9 10 11	10 11 12	11 12 13	12 13 14	13 14 15	14 15 16
5 6 7	6 7 8		7 8 9	8 9 10	9 10 11	10 11 12	11 12 13	12 13 14	13 14 15	14 15 16	15 16 17	16 17 18	17 18 19
1 2 3	2 3 5	3 5 6		5 6 7	6 7 8	7 8 9	8 9 10	9 10 11	10 11 12	11 12 13	12 13 14	13 14 15	14 15 16
5 6 7	6 7 8	7 8 9		8 9 10	9 10 11	10 11 12	11 12 13	12 13 14	13 14 15	14 15 16	15 16 17	16 17 18	17 18 19
1 2 3	2 3 4	3 4 6	4 6 7		6 7 8	7 8 9	8 9 10	9 10 11	10 11 12	11 12 13	12 13 14	13 14 15	14 15 16
4 6 7	6 7 8	7 8 9	8 9 10		9 10 11	10 11 12	11 12 13	12 13 14	13 14 15	14 15 16	15 16 17	16 17 18	17 18 19
1 2 3	2 3 4	3 4 5	4 5 7	5 7 8		7 8 9	8 9 10	9 10 11	10 11 12	11 12 13	12 13 14	13 14 15	14 15 16
4 5 7	5 7 8	7 8 9	8 9 10	9 10 11		10 11 12	11 12 13	12 13 14	13 14 15	14 15 16	15 16 17	16 17 18	17 18 19
1 2 3	2 3 4	3 4 5	4 5 6	5 6 8	6 8 9		8 9 10	9 10 11	10 11 12	11 12 13	12 13 14	13 14 15	14 15 16
4 5 6	5 6 8	6 8 9	8 9 10	9 10 11	0 11 12		11 12 13	12 13 14	13 14 15	14 15 16	15 16 17	16 17 18	17 18 19
1 2 3	2 3 4	3 4 5	4 5 6	5 6 7	6 7 9	7 9 10		9 10 11	10 11 12	11 12 13	12 13 14	13 14 15	14 15 16
4 5 6	5 6 7	6 7 9	7 9 10	9 10 11	0 11 12	11 12 13		12 13 14	13 14 15	14 15 16	15 16 17	16 17 18	17 18 19
1 2 3	2 3 4	3 4 5	4 5 6	5 6 7	6 7 8	7 8 10	8 10 11		10 11 12	11 12 13	12 13 14	13 14 15	14 15 16
4 5 6	5 6 7	6 7 8	7 8 10	8 10 11	0 11 12	11 12 13	12 13 14		13 14 15	14 15 16	15 16 17	16 17 18	17 18 19
1 2 3	2 3 4	3 4 5	4 5 6	5 6 7	6 7 8	7 8 9	8 9 11	9 11 12		11 12 13	12 13 14	13 14 15	14 15 16
4 5 6	5 6 7	6 7 8	7 8 9	8 9 11	9 11 12	10 12 13	12 13 14	13 14 15		14 15 16	15 16 17	16 17 18	17 18 19
1 2 3	2 3 4	3 4 5	4 5 6	5 6 7	6 7 8	7 8 9	8 9 10	9 10 12	10 12 13		12 13 14	13 14 15	14 15 16
4 5 6	5 6 7	6 7 8	7 8 9	8 9 10	9 10 12	10 12 13	12 13 14	13 14 15	14 15 16		15 16 17	16 17 18	17 18 19
1 2 3	2 3 4	3 4 5	4 5 6	5 6 7	6 7 8	7 8 9	8 9 10	9 10 11	10 11 13	11 13 14		13 14 15	14 15 16
4 5 6	5 6 7	6 7 8	7 8 9	8 9 10	9 10 11	10 11 13	11 13 14	13 14 15	14 15 16	15 16 17		17 18 19	18 19 20
1 2 3	2 3 4	3 4 5	4 5 6	5 6 7	6 7 8	7 8 9	8 9 10	9 10 11	10 11 12	11 12 13	12 13 14	13 14 15	14 15 16
4 5 6	5 6 7	6 7 8	7 8 9	8 9 10	9 10 11	10 11 12	11 12 13	12 13 14	13 14 15	14 15 16	15 16 17	16 17 18	17 18 19

$R_F(n)=$

Figure 7.5 Alternate routing for the fully connected net

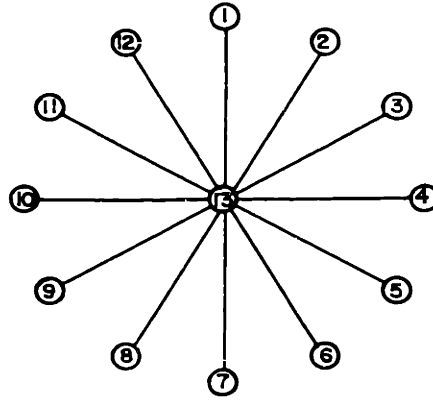

$I_s =$

	1	2	3	4	5	6	7	8	9	10	11	12	13
1													1
2													1
3													1
4													1
5													1
6													1
7													1
8													1
9													1
10													1
11													1
12													1
13	1	1	1	1	1	1	1	1	1	1	1	1	

$R_s =$

	1	2	3	4	5	6	7	8	9	10	11	12	13
1		13	13	13	13	13	13	13	13	13	13	13	13
2	13		13	13	13	13	13	13	13	13	13	13	13
3	13	13		13	13	13	13	13	13	13	13	13	13
4	13	13	13		13	13	13	13	13	13	13	13	13
5	13	13	13	13		13	13	13	13	13	13	13	13
6	13	13	13	13	13		13	13	13	13	13	13	13
7	13	13	13	13	13	13		13	13	13	13	13	13
8	13	13	13	13	13	13	13		13	13	13	13	13
9	13	13	13	13	13	13	13	13		13	13	13	13
10	13	13	13	13	13	13	13	13	13		13	13	13
11	13	13	13	13	13	13	13	13	13	13		13	13
12	13	13	13	13	13	13	13	13	13	13	13		13
13	1	2	3	4	5	6	7	8	9	10	11	12	

Figure 7.6 The star net

At this point, it is convenient to comment on the sample size used in the simulation experiments. Clearly, we desire a sufficiently large sample so as to obtain an accurate measure of the recorded statistics. We quote a result due to Morse [40] for a single exponential channel facility which gives an approximate expression for D , the relaxation time to go from a mean square deviation away from the average queue length back to $1/e$ (where e is the base of natural logarithm) of this deviation:

$$\mu CD \cong \frac{2\rho}{(1-\rho)^2}$$

where we have altered his notation to correspond to that used in our Appendix A. The interesting behavior to observe is that the relaxation time D depends upon the inverse square of $(1-\rho)$; this exposes a great sensitivity to ρ as $\rho \rightarrow 1$. In order to illustrate a similar dependence in a network of queues, we show in Fig. 7.7, the values of μCT

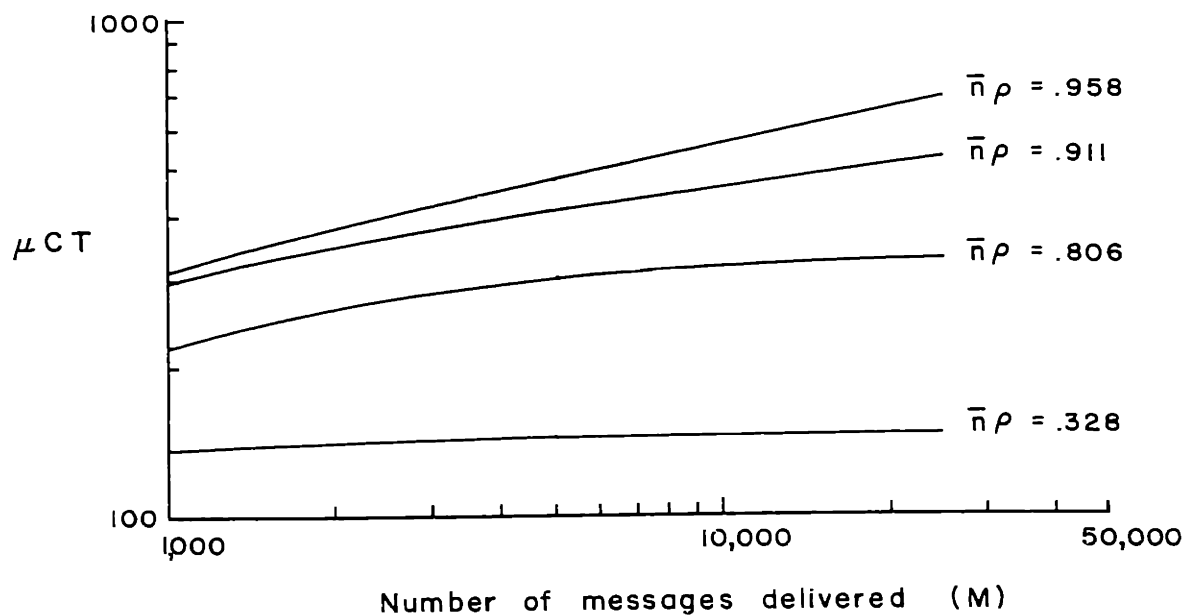

Figure 7.7 Effect of sample size on the average message delay (for the diamond net and traffic matrix τ_1).

(obtained from simulation of the diamond net with traffic matrix τ_1) as a function of M , the number of messages delivered to their destination; the parameter for this figure is $\bar{n}\rho$. As expected, we observe a strong dependence on $\bar{n}\rho$ in the network. In all simulations described in this thesis, the procedure used to determine when a sufficient number of messages has been processed was to observe μCT at various values of M ; when these observed values levelled off sufficiently, the simulation was halted, thus insuring that a significant sample had been used.

7.2 Simulation Results

Some results from the simulation programs have already been described in previous chapters. In particular, Sect. 3.5 describes the use of the program in analyzing the dependent character of the traffic as it leaves a node. The simulation was used to experimentally investigate the validity of the conservation law (see Chap. V) for nets. In Sect. 6.5, the program was used to generate experimental results for a K -connected net with fixed routing, in order to compare these results with derived results for random routing procedures. We now proceed to describe a set of experimental simulations for the purpose of comparing the message delay for different capacity assignment rules, different routing procedures, and different network topologies. We note here that the simulations were run without the use of the Independence Assumption.

The results of Theorems 4.2 and 4.4, and of Eq. 4.2 indicate that the average message delay in a queueing system is minimized when the traffic is concentrated into as few channels as possible. We note, however, that alternate routing has the tendency to disperse traffic rather than to cluster it. We may therefore expect that alternate routing will yield message delays larger than that of fixed routing. Indeed, this is so, as may be observed in Figs. 7.8 a-d. These figures display the message delay T (multiplied by μC for purposes of normalization) for traffic flow through the diamond net. Figures 7.8 a-c

show μCT as a function of the routing procedure $(R_{d1}, R_{d2}, R_{d3}, R_{d4})$ for three different values of $\rho = \gamma/\mu C$ with traffic matrix τ_1 . Figure 7.8d shows a similar graph for traffic matrix τ_2 . Three curves are shown in each of the figures: one for the identical capacity assignment, one for the proportional capacity assignment,* and one for the square root assignment. The first observation to make from these curves is that the square root assignment results in a considerably smaller message delay than does either of the other two assignments; in fact, it is preferable over a number of other capacity assignments that were tried experimentally. Not only was the square root assignment superior in the case of fixed routing procedures (as predicted by Theorem 4.5), but also in the case of various degrees of alternate routing.

The second observation is that the introduction of increasing degrees of alternate routing (plotted on an arbitrary horizontal scale) resulted in a deterioration of performance (when the square root assignment was used). For the identical and proportional capacity assignments, the introduction of alternate routing improved the performance at low values of $\gamma/\mu C$. One notes in Figs. 7.8(a-c) that the alternate routing described by the matrix R_{d1} resulted in a convergence of the three curves. This is not a general result (as evidenced by Fig. 7.8d) but is due both to the fact that the alternate routing procedure for τ_1 did not result in important path length changes for the messages, and also to the fact that in the case of full alternate routing, the traffic tends to distribute itself in proportion to the capacity of the channels, thus resulting effectively in a system where traffic and capacity are proportional; this assignment defeats the square root assignment of capacity. In the curves of Fig. 7.8d this convergence was not observed since the introduction of alternate routing produced a significant change in the message path length.

* This assignment of capacity in proportion to the traffic carried results in a constant utilization factor for each channel in the net, and is a reasonable assignment to consider on intuitive grounds.

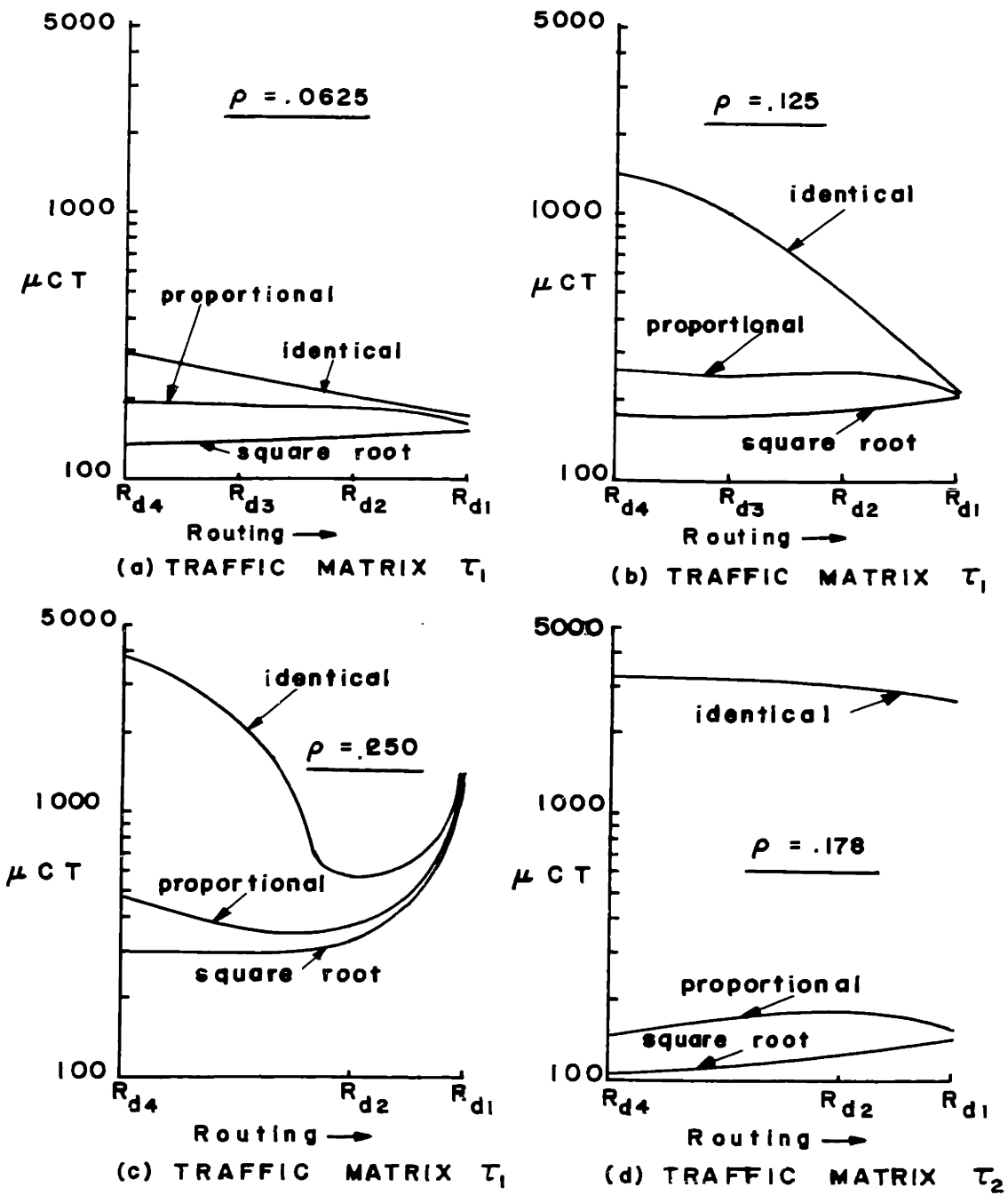

Figure 7.8 Effect of routing procedure and channel capacity assignment on the average message delay for the diamond net.

Figure 7.9 shows similar plots for the fully connected net for the traffic matrix τ_1 . Once again, we observe that the square root assignment is superior to both the proportional and identical capacity assignments and also that fixed routing is superior to alternate routing, with a square root assignment rule. Further, it is clear that any alternate path in this fully connected net must at least double the path length as compared to fixed routing, and so we do not see the convergence at heavy alternate routing here that we saw in Figs. 7.8(a-c)

Whereas the introduction of alternate routing caused longer message delays (for the optimum channel capacity assignment), we find that the simulation results expose the ability of alternate routing procedures to adapt the flow of traffic so as to match the network topology. For example, Fig. 7.8b illustrates the improved performance due to alternate routing in the case of a poor capacity assignment (the identical capacity assignment). This adaptive behavior of alternate routing procedures has considerable significance in the realistic design and operation of a communication net. Specifically, it is generally true that the actual traffic matrix is not known precisely at the time the network is being designed; indeed, even if the traffic matrix were known, it is probable that the entries, γ_{jk} , in this matrix would be time-varying (i.e., different traffic loads exist at different hours of the day, different days of the week, different seasons of the year, etc.). In the face of either this uncertainty or variation, or both, it becomes impossible to calculate the optimum channel capacity assignment from Eq. 4.7 since the numbers λ_i (which are calculable from the γ_{jk} under a fixed routing procedure) are in doubt. One solution to this problem is to use some form of alternate routing which then adapts the actual traffic flow to the network. Note, however, that a price must be paid for such flexibility, since fixed routing with the square root capacity assignment is itself superior to alternate routing (assuming we have known, time-invariant γ_{jk}), as may be seen in Figs. 7.8 and 7.9.

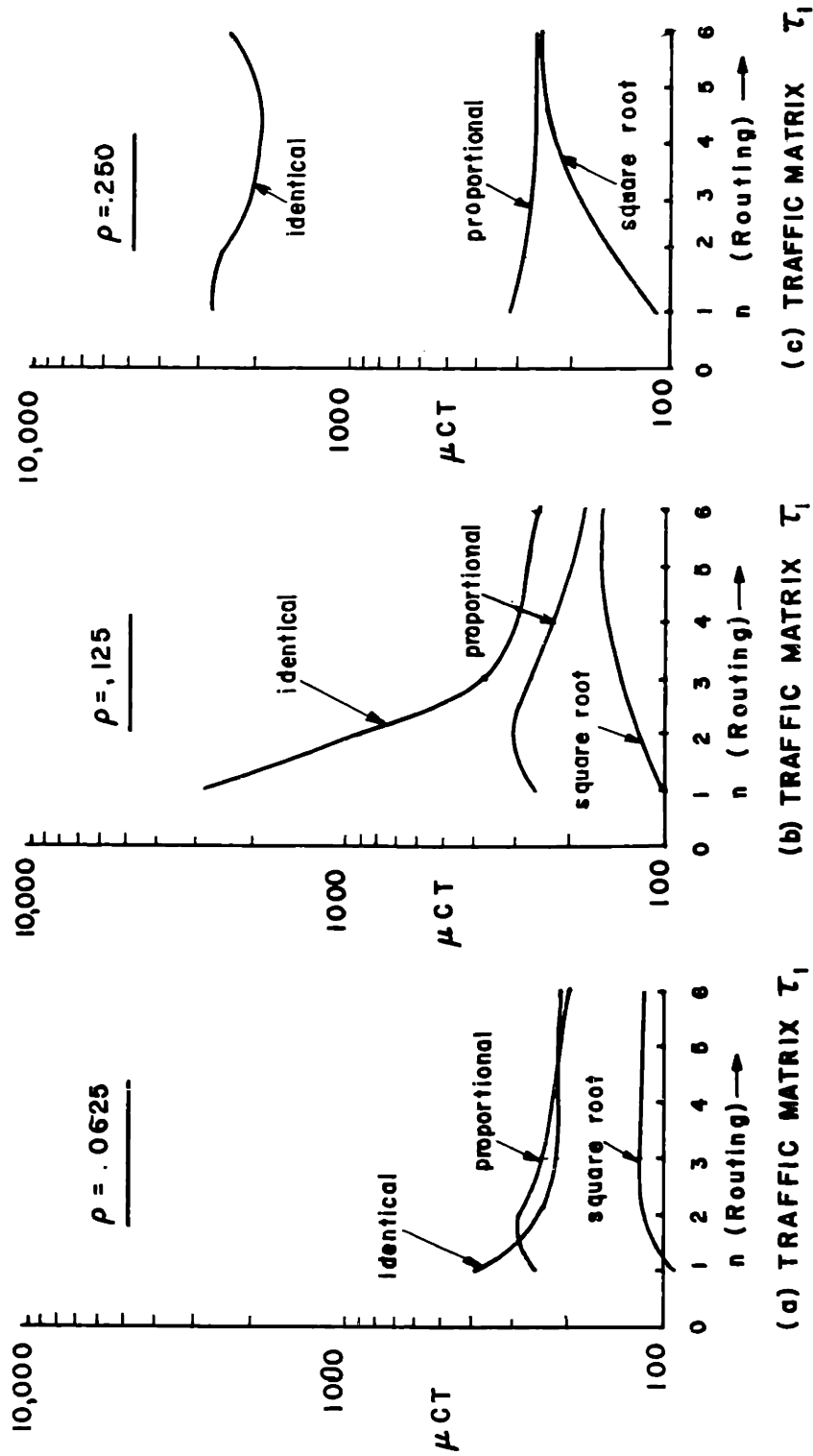

Figure 7.9 Effect of routing procedure and channel capacity assignment on the average message delay for the fully connected net.

Having observed the effect of routing and of channel capacity assignment, we now consider the effect of topology on the message delay. Once again, we refer to Theorems 4.2, 4.4, and to Eq. 4.2 which suggest the clustering of traffic and capacity. The star net topology achieves this clustering in a very efficient manner. In particular, this net has the property that as much traffic as possible is grouped into each channel, subject to the constraint that at least one channel must enter and leave each node in the net. This physical constraint is due to the fact that the traffic matrix (i. e., the set of origins and destinations) is specified independent of the network design, and, in general each node will serve as an origin for some traffic, and as a destination for some other traffic. Note that the star net achieves exactly one channel leading in and out of each node, save for the central node. The cost in terms of additional path length is less than twice that of the fully connected net (which clearly represents the net with the minimum path length for each message).

The behavior of the star net is contrasted with that of the diamond, the K-connected and the fully connected net in Figs. 7.10a, b. Both figures display the experimentally obtained message delay for the four nets, for traffic matrix τ_1 ; Fig. 7.10a is for the case of a square root capacity assignment, and Fig. 7.10b is for the identical capacity assignment. We note first that the star net is superior in its operation over most of the investigated range for both capacity assignments. Furthermore, the square root assignment is clearly superior in all cases, to the identical capacity assignment (this is not surprising since the traffic in τ_1 is non-uniformly distributed). Figures 7.11a, b show the same comparison for the uniform traffic matrix τ_3 . Here again, the star net is best over the range tested. We note that the square root assignment is not significantly better than the identical capacity assignment in this case. This points out the interesting fact that when all λ_i are the same, it is then clear from their definition, that all three capacity

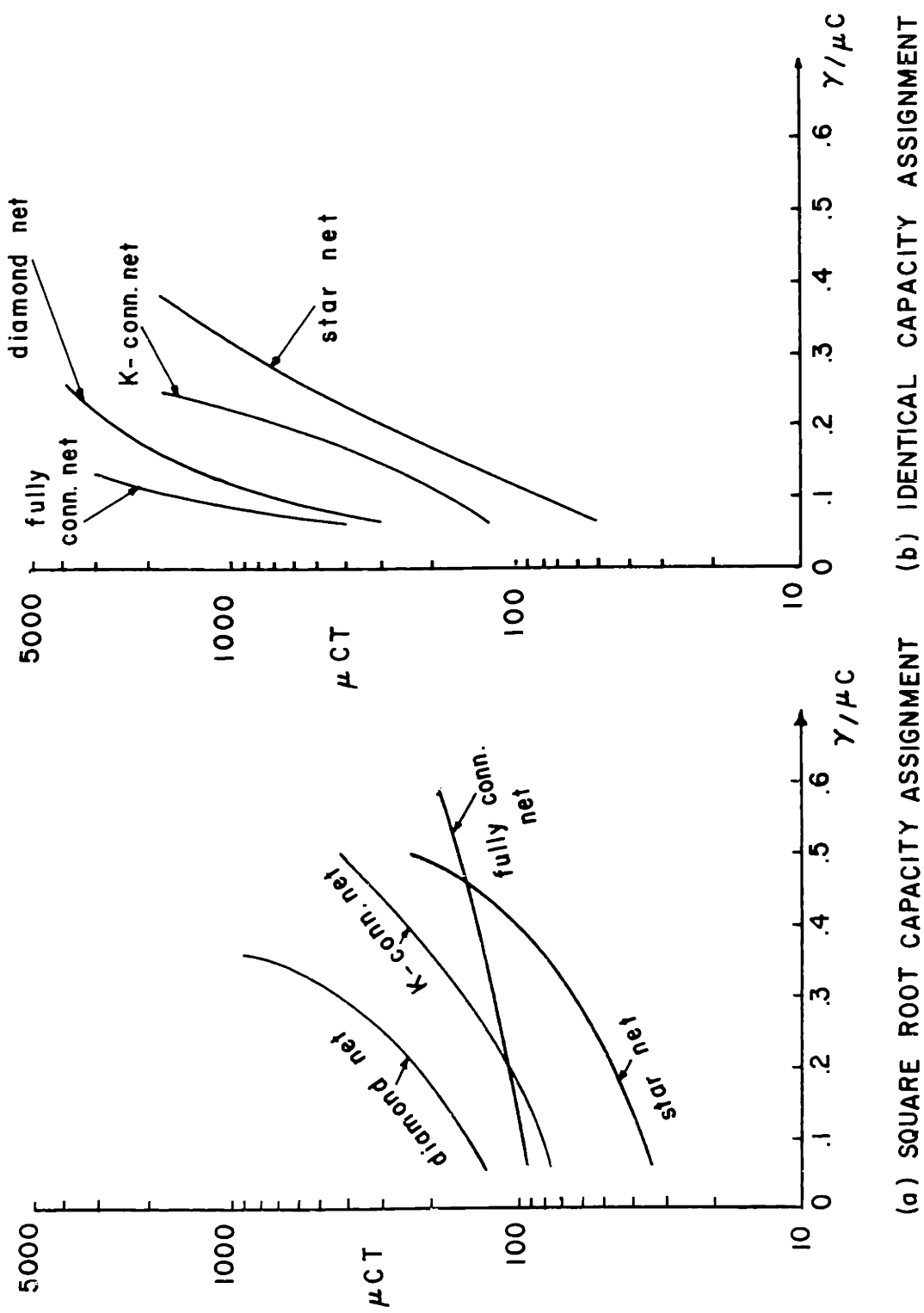

Figure 7.10 Effect of network topology on the average message delay for a fixed routing procedure and for the highly non-uniform traffic matrix τ_1 .

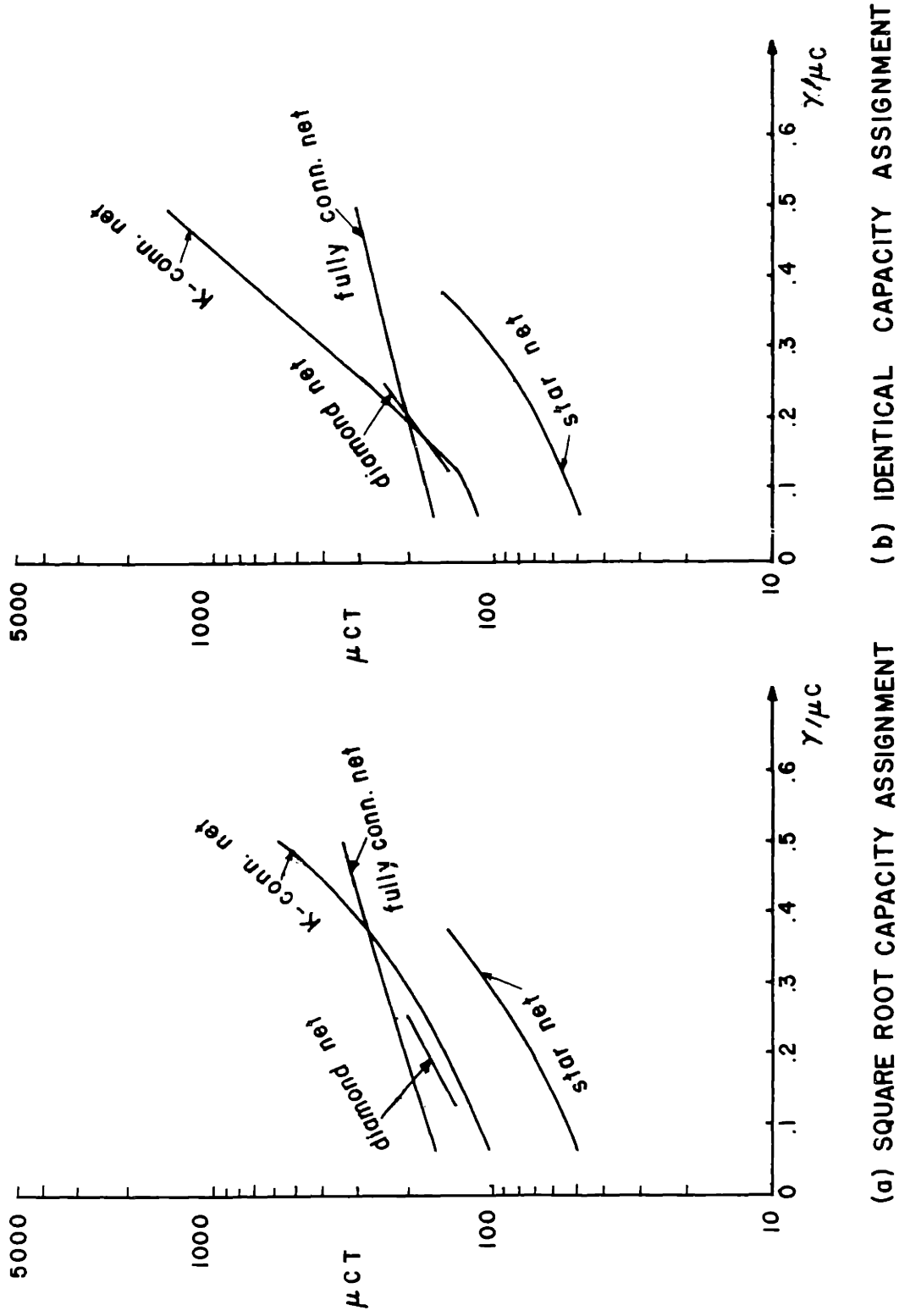

Figure 7.11 Effect of network topology on the average message delay for a fixed routing procedure and for the uniform traffic matrix T_3 .

assignments yield the same results, namely, all identical capacity assignments. Upon comparing Figs. 7.10a and 7.11a, we see that the square root assignment gives better results for the non-uniform traffic matrix τ_1 , than for the uniform traffic matrix τ_3 (one should only compare the curves for the star and the fully connected nets here, since the average path length for the other two nets is a strong function of the traffic matrix). The point to be made here is that the square root assignment becomes increasingly more advantageous over the other forms of capacity allocation as the traffic pattern becomes more and more non-uniform; in fact, a highly non-uniform traffic pattern is precisely what Theorem 4.4 states will yield a minimum message delay.

Theorem 4.5 describes the optimum channel capacity assignment and gives the expression for the average message delay for a communication net with a fixed routing procedure subject to the constraint of constant total channel capacity. The effect of the distribution of traffic (λ_i) and the average path length (\bar{n}) on the average message delay may be seen in Eq. 4.18. Specifically, we observe again that increased clustering of the traffic reduces the expression $\sum_i \sqrt{\lambda_i/\lambda}$ (where i ranges over the entire set of channels in the net). Furthermore, we note that T grows without bound at $\rho \rightarrow 1/\bar{n}$, and so we desire to minimize \bar{n} as well. It is clear that the value of \bar{n} is dependent upon the set of values λ_i . In particular, for the star net, (which has a maximally concentrated traffic pattern) $1 < \bar{n} < 2$. If we require a reduced \bar{n} , we must add channels to the star net, thus destroying some of the clustering of traffic. In the limit as $\bar{n} \rightarrow 1$, we arrive at the fully connected net which has the smallest possible \bar{n} , but also the most dispersed traffic pattern. The trade-off between \bar{n} and traffic clustering depends heavily upon ρ . In particular, we find that at low network load, nets similar to the topology of the star net are optimum; as the network load increases, we obtain the optimum topology by reducing \bar{n} (by adding additional channels); and finally, as $\rho \rightarrow 1$, we require $\bar{n} = 1$ which results in the fully connected net. In all cases, we use the square root channel capacity assignment with a

fixed routing procedure.* These conclusions were tested and verified by additional simulation experiments. In particular, we simulated just such a sequence of nets, starting with the star net, introducing additional channels, and finally arriving at the fully connected net. Figure 7.12 shows these results for the uniform traffic matrix (τ_3) with fixed routing and a square root channel capacity assignment. The 1/3 and 2/3 connected nets refer to a star net to which have been added enough direct channels so as to achieve nets with 1/3 (or 2/3) of the total number of connections possible. Clearly, at low values of $\rho = \gamma/\mu C$, the pole in Eq. 4.18 is of small consequence and so the dominating term is $\left(\sum_i \sqrt{\lambda_i/\lambda}\right)^2$; in such a case, the star net is optimum since it minimizes this sum. As ρ increases, the pole takes on more importance, and so \bar{n} must be decreased by adding links, which results in a sacrifice of clustered traffic. Finally, as $\rho \rightarrow 1$, the denominator in Eq. 4.18 dominates, so we must minimize \bar{n} with no regard to the cluster. The optimum behavior over the entire range of ρ is then the minimum envelope of the family of curves which correspond to this sequence of topologies. The optimum topology at any particular value of ρ may be found by observing the behavior of T in Eq. 4.18 as more direct channels are added; this function will pass through a minimum as the channels are introduced and the topology corresponding to this minimum represents the optimum topology (for the particular value of ρ considered). In the case of a non-uniform traffic matrix, we expect a slightly different behavior; this is illustrated in Fig. 7.13 for the highly non-uniform traffic matrix τ_1 . Here we see that even for small values of ρ , the introduction of some direct links (between those nodes which carry the bulk of the traffic) is required. However, the addition of the remainder of the links only becomes necessary as ρ increases (as in the uniform traffic case).

* It is interesting to note that the steady flow problem (i.e., no storage in the system, and a continuous constant flow) leads to the fully connected topology also with just enough capacity between each pair of nodes to satisfy the required flow. This solution, as in our case, assumes no notion of distance measure between the nodes.

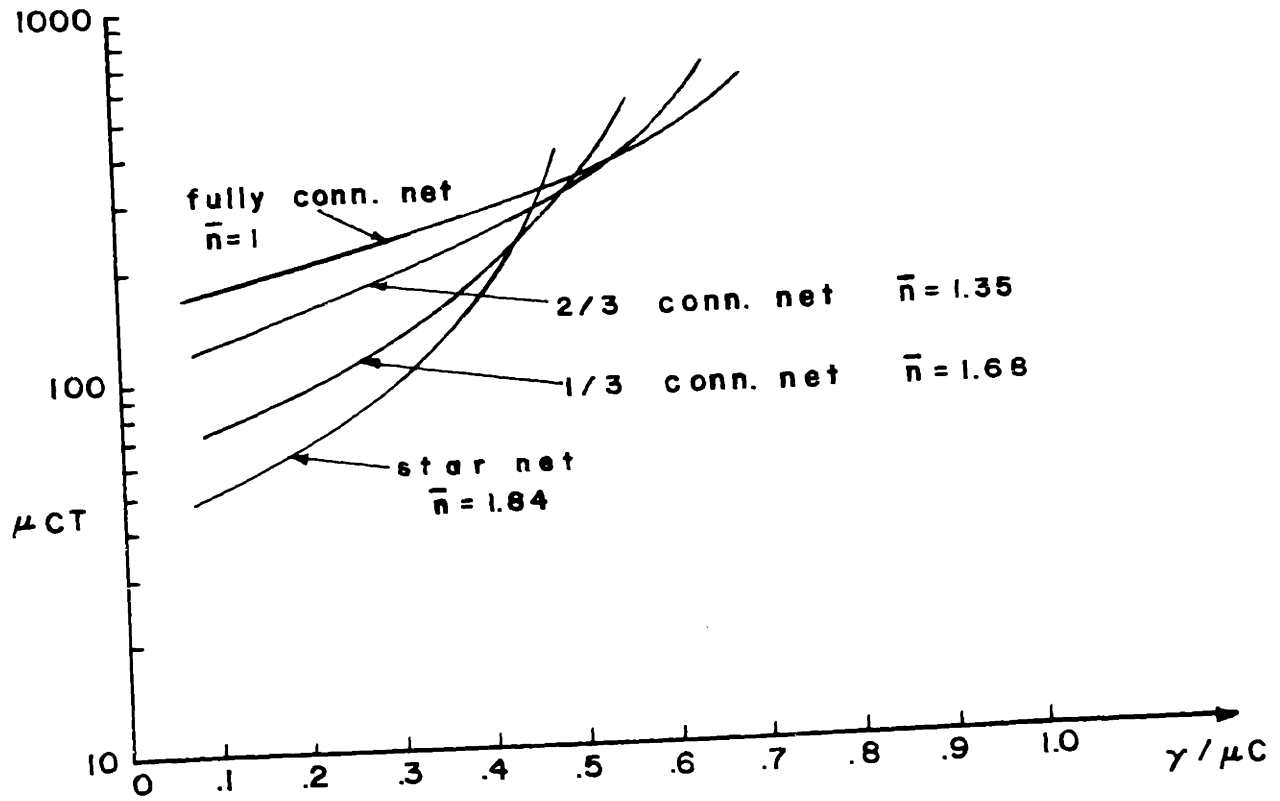

Figure 7.12 Effect of adding channels to the star net with a fixed routing procedure, a square root channel capacity assignment, and a highly uniform traffic matrix τ_3 .

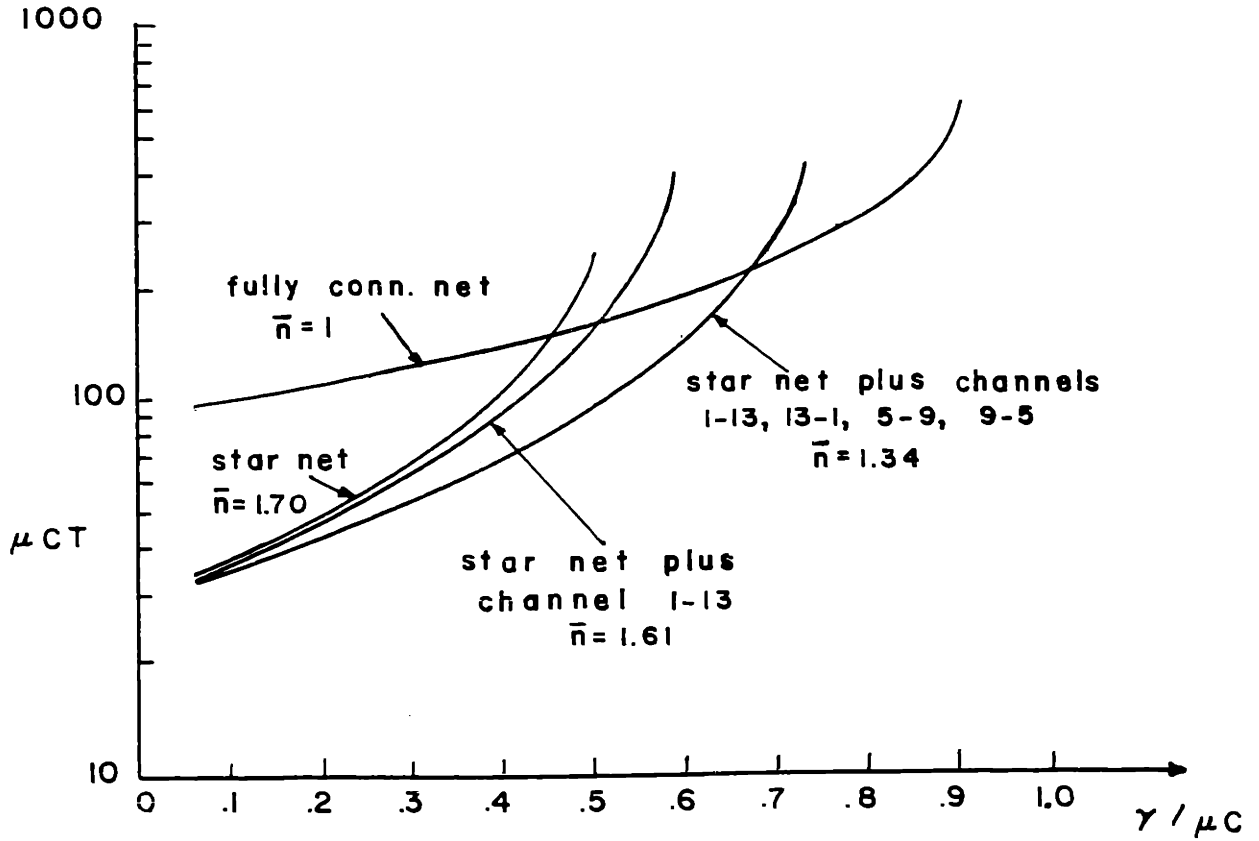

Figure 7.13 Effect of adding channels to the star net with a fixed routing procedure, a square root channel capacity assignment, and a highly non-uniform traffic matrix τ_1 .

7.3 Additional Theorems on Alternate Routing Procedures

In Section 7.2, we observed that the specific form of alternate routing procedure used gave rise to an increase in message delay under the square root assignment. It was pointed out that this was not surprising in the light of our theoretical findings. In that regard, we now present two theorems: the one offering analytic proof of the superiority of fixed routing with additional constraints on the net; and the other analyzing a more sophisticated form of alternate routing.

Consider a net with a fixed total channel capacity which is fed by messages which have exponentially distributed inter-arrival times (i.e., Poisson arrivals), and which have lengths which are chosen independently from the same exponential distribution each time the message enters a node (i.e., the Independence Assumption). Also, consider any alternate routing procedure which results in internal network traffic which is also Poisson. For this situation, we state the following

THEOREM 7.1*

Consider any node (say node n_1) in the network, from which there are two alternate paths** of the same length, both paths leading to the same node (say node n_2). Then, the message delay can always be reduced by omitting one of these paths as an alternate route for messages travelling from n_1 to n_2 .

This theorem says, in essence, that a fixed route (i.e., a single path) is superior to alternate routing in the case where the introduction of an alternate path does not affect the path length. Of course, this result is restricted by the assumptions above, and only

* See Appendix F for proof of this theorem.

**By alternate paths, we mean paths which are allowed by the routing procedure.

gives partial evidence of the advantages of fixed routing procedures.

The form of alternate routing procedure employed in the simulation experiments was extremely simple and unsophisticated. We now discuss a refinement on the procedure for offering alternate routes to the message traffic .

We approach the problem from the point of view of a single node extracted from the net. Consider such a node, with N channels emerging from it. We assume that all of these channels connect to either the same node, or to a set of nodes, any one of which is an equally satisfactory next node to visit. However, we assume that all of the channels are of different capacity. In fact, we choose to label the channels such that

$$C_1 > C_2 > C_3 > \dots > C_N \quad (7.1)$$

The other assumptions about the system are: arrivals are Poisson; message lengths are independently and exponentially distributed with mean length $1/\mu$; and the queue discipline is first come first served. When a channel becomes free, it is offered to the first message in the queue; if the first message does not want the channel, it is offered to the second message, etc. If no messages want the free channel, then it remains idle until possibly some new message entering the system desires it.

We now inquire as to the conditions under which a message should accept channel C_i . Specifically, let n_i be that position in the queue at which a message should accept channel C_i (that is, any message in position less than n_i is not interested in accepting channel C_i). The criterion used is such that a message will accept channel C_i if and only if the acceptance of this channel reduces the message's expected time spent in the system. In all cases, we assume that no message has any knowledge about the exact length of any other message, including its own length.

Applying the above criterion to the system leads to the following

THEOREM 7.2*

For the system described above, a message should accept channel C_i if and only if its position, n_i , in the queue satisfies the following inequalities

$$n_i - 1 < (S_{i-1}/C_i) - 1 \leq n_i \quad i = 2, 3, \dots, N \quad (7.2)$$

and where

$$S_{i-1} = \sum_{j=1}^{i-1} C_j \quad (7.3)$$

One observes that these rules are not complicated, and add an interesting degree of sophistication to the simpler alternate routing schemes considered earlier.

7.4 Conclusion

If we consider message delay to be the measure of a net's performance, then we inquire as to the effect on performance as we vary the following three design parameters: channel capacity assignment; routing procedure; and topological network structure. In the simulation experiments described in this chapter, we have been able to demonstrate some interesting behavior in regard to these design parameters, while holding fixed the total channel capacity assigned to the net. Specifically, the average message delay is highly sensitive to the average path length \bar{n} and to the distribution of λ_i (which can be thought of as representing the degree of cluster in the internal traffic). These two interact with each other, and may not be minimized independently. The recognition of these two quantities as underlying the behavior of the average message delay allows us

* See Appendix F for proof of this theorem.

to theoretically predict and experimentally observe a number of useful characteristics of communication nets. We list these below.

- (1) The square root channel capacity assignment as described in Eq. 4.7 results in superior performance as compared to a number of other channel capacity assignments.
- (2) The performance of a straightforward fixed routing procedure, with a square root capacity assignment, surpasses that of a simple alternate routing procedure.
- (3) The alternate routing procedure adapts the internal traffic flow to suit the capacity assignment. (i. e., the bulk of the message traffic is routed to the high capacity channels). This effect is especially noticeable and important in the case of a poor capacity assignment which may come about due to uncertainty or variation in the applied message traffic.
- (4) A high degree of non-uniformity in the traffic matrix results in improved performance for the case of a square root channel capacity assignment (due to a more clustered traffic pattern).
- (5) The quantities essential to the determination of the average message delay are the average path length and the degree to which the traffic flow is clustered.

It is interesting to note that the trade-off between the average path length and the clustering of the traffic results in a sequence of optimum network topologies which range from the star net to the fully connected net. Indeed, the star net has the property of maximally clustered traffic (but an average path length close to two), and the fully connected net has the minimum average path length ($\bar{n} = 1$) but the maximally dispersed traffic. These two

extreme cases bound the range of optimum nets, and the optimum topology for a particular value of network load (ρ) lies somewhere between them.

Two theorems involving alternate routing procedures were proven. The first theorem gave partial evidence of the superiority of fixed routing procedures. The second theorem introduced and analyzed a new alternate routing procedure in which a message had the option of passing by a free channel of low capacity, and waiting a little longer for a higher capacity channel.

CHAPTER VIII

CONCLUSION

8.1 Summary

The description of the experimental results from simulation completes our present investigation of communication nets. We found that the introduction of the Independence Assumption into our model of a communication net was necessary for the analytic treatment of the problem; in addition, as discussed in Chap. III, the approximation due to this assumption is quite good.

Theorems 4.2, 4.4, and Eq. 4.2 all indicate that message delay can be minimized by clustering the traffic into a small number of high capacity channels; small here is ideally to be interpreted as unity, however, certain physical constraints on the network often place a lower bound on the number of channels which exceeds unity. Theorem 4.5 describes the optimum channel capacity assignment and gives the expression for the average message delay for a communication net with a fixed routing procedure subject to the constraint of constant total channel capacity. We recognize from this theorem that the average path length and the degree to which the internal traffic is concentrated play an essential role in determining the average delay to a message.

The study of priority disciplines led to two useful conclusions. First, the delay dependent priority structure provides the system designer with a number of degrees of freedom with which to manipulate the relative waiting times for each priority group. Second, the conservation law (Theorem 5.4) allows one to draw a number of general conclusions about the average waiting times for a large class of priority structures.

The investigation of random routing procedures in Chap. VI pointed out that,

relative to fixed routing procedures, the disadvantages are: increased path lengths for messages; increased message delay at each node; and a reduction in the total average traffic that the network can accommodate.

The digital simulation program was used to study the behavior of a number of different nets, as described in Chap. VII. The program served a multiple purpose by allowing the verification of theoretically predicted results and the investigation of mathematically intractable problems; furthermore, a number of suggestive ideas were obtained from the results of the experiments. Specifically, the major results that emerged from the simulation are:

- (1) The square root channel capacity assignment as described in Eq. 4.7 results in superior performance as compared to a number of other channel capacity assignments.
- (2) The performance of a straightforward fixed routing procedure, with a square root capacity assignment, surpasses that of a simple alternate routing procedure.
- (3) The alternate routing procedure adapts the internal traffic flow to suit the capacity assignment (i. e., the bulk of the message traffic is routed to the high capacity channels). This effect is especially noticeable and important in the case of a poor capacity assignment which may come about due to uncertainty or variation in the applied message traffic.
- (4) A high degree of non-uniformity in the traffic matrix results in improved performance for the case of a square root channel capacity assignment (due to a more clustered traffic pattern).

- (5) The quantities essential to the determination of the average message delay are the average path length and the degree to which the traffic flow is clustered. The trade-off between these two quantities allows one to determine the sequence of optimal network topologies which ranges from the star net at small values of network load to the fully connected net as the network load approaches unity.

The general problem discussed in this thesis has been the minimization of the average message delay, with respect to the channel capacity assignment, the routing procedure, the priority discipline, and the network topology, subject to the constraint of a fixed total channel capacity assigned to the net. The problem statement may be expressed as

$$\begin{array}{l} \text{minimize} \\ \left. \begin{array}{l} \text{cap'y. ass.} \\ \text{rout. proc.} \\ \text{priority disc.} \\ \text{topology} \end{array} \right\} \end{array} \sum_{i=1}^N \frac{\lambda_i}{\gamma} T_i \quad \text{subject to} \quad (8.1)$$

$$\sum_{i=1}^N C_i = C \quad (8.2)$$

where N is the number of channels in the net (N may vary as the topology varies).

We note, from Eq. C. 1, that the above minimization of message delay is equivalent to minimizing the total average number of messages in the net; i.e., $\lambda_i T_i$ is the average number of messages waiting for or being transmitted on the i^{th} channel.

Furthermore, when we compare the form for T (as expressed in Eq. 4.5) with the conservation law (Theorem 5.4), we observe that all the results we have obtained for T apply equally well to any queue discipline which falls in the class as defined by that theorem.

8.2 Suggestions for Further Investigations

The model of a communication net which we have chosen to investigate is clearly an idealization of real communication systems. It would be rather useful to relax a number of the restrictions, leaving a model still capable of analysis. For example, the desirability of a star net topology would be highly questionable in a network which did not have perfectly reliable nodes and links. The assumption of noiseless communication channels has simplified our analysis; the removal of this restriction will probably lead to a system wherein the considerations are not vastly different from those in the noiseless case. Introducing more general message traffic (such as multi-destination messages, and mixtures of data and direct traffic) would greatly extend the field of application of our communication network study. Along with the notion of message defection goes the possibility of finite storage capacity at each node; this generalization is also a line for future investigation. We restate the assumption of stationary Poisson-exponential statistics for the external message sources; more general distributions would be extremely interesting to study. One of the more difficult mathematical problems is that of solving for the statistics of the internal traffic flow within a communication net. An indication of the scope and source of the difficulty, and some partial answers to the problem are given in Chap. III; these complications led to the introduction of the Independence Assumption.

The alternate routing procedure used in the simulation experiments is of a rather elementary form; a more sophisticated procedure is described in Sect. 7.3, and bears further investigation.

An interesting generalization of the channel capacity assignment stated in Eq. 4.7 is given in Theorem 4.6. Specifically, the theorem solves for the optimum channel capacity assignment and for the resultant average message delay for a communication net subject to the following constraint (which replaces the constraint expressed in Eq. 4.4):

$$\sum_{i=1}^N C_i d_i = D \quad (8.3)$$

where C_i is the channel capacity of the i^{th} transmission channel, and d_i is a function independent of the capacity C_i , and reflects the cost, in dollars say, of supplying one unit of channel capacity to the i^{th} channel. The quantity D represents the total number of dollars that are available to spend in supplying the N channel system with the set of capacities C_i . The actual values of the set d_i depend upon the particular communication net involved; for example, d_i might be chosen to represent the length of the i^{th} channel. It would be interesting to see exactly what one can say about the topological design of a net with this new set of constraints; perhaps the topologies involved would consist of many small groups of nodes, each group connected together in a manner not unlike that described in Chap. VII, and the set of groups then connected together in a similar topology, etc. (i.e., a hierarchy of topologies, the basic element of which is chosen as one of the members in the sequence which ranges from the star net to the fully connected net).

As mentioned above, the notion of unreliable nodes and links is one that needs

consideration. Indeed, a most interesting problem statement which incorporates the extension to unreliability as well as to the more general cost function described by Eq. 8.3 may be expressed as

$$\begin{array}{ll} \text{minimize} & AT + BU \\ \left. \begin{array}{l} \text{cap'y. ass.} \\ \text{rout. proc.} \\ \text{priority disc.} \\ \text{topology} \end{array} \right\} & \text{subject to the fixed cost constraint} \\ & \text{as expressed in Eq. 8.3} \end{array}$$

where A and B represent one's dislike for a unit of message delay (T) and unreliability (U) respectively. Of course, the function U will consist of an appropriately defined measure of the unreliability.

Most of the suggested extensions listed above bring one face to face with mathematically intractable problems. It seems appropriate to suggest that rather than perform an exact analysis on these extended models, one should approach the problem with the intent of obtaining approximate or limiting analytic results. Furthermore, the verification of these results, and indeed, in some cases, the only source for getting them, may be obtained through the use of a communication network simulator such as described in Appendix E.

APPENDIX A
REVIEW OF SIMPLE QUEUEING SYSTEMS*

A queue is a waiting line. Examples of queues occur constantly in our daily living: a line of cars in front of a toll booth; water backed up by a dam; customers at the check-out counter of a supermarket; messages awaiting transmission at a communication center, etc. In order to have a process in which queues can form, we require arrivals (of cars, water, people, messages, etc.) and a service facility which performs some operation on the arrivals (collecting the toll, releasing the water, checking out customers, transmitting messages).

Thus, we have a process involving flow. It becomes immediately obvious that if we hope to contend with this flow, we must insure that the capacity of our servicing facility is sufficient to handle the average flow rate. If the flow is a steady flow, then we have a straightforward problem**. If, however, the flow comes in spurts or in any other non-uniform fashion, then we can expect queues to form in front of the service facility even if the capacity of the facility exceeds the average input flow rate. The formation of a queue occurs when a higher than average flow occurs and saturates the service facility; at times when the flow is smaller than average, the service facility may find itself idle for some period.

* The material presented in this appendix is intended to acquaint the reader with some of the basic notions and results well-known in queueing theory which have application in our study of communication networks. For those readers with a knowledge of elementary queueing theory, it might be well to pass over this material.

**For example, consider an escalator, in a department store, which can accept up to R_1 passengers per second. If the rate, R , at which customers arrive at the escalator is constant (i.e., a steady input flow), then either $R \leq R_1$, in which case no queues form, and the steady flow is sustained, or else $R > R_1$, in which case the queue will grow without bound, and the system will be saturated.

Queueing theory deals with the description and analysis of the effects of such a fluctuating flow. It is the purpose of this appendix to present certain of the well-known results for some simple queueing systems, so as to expose the characteristic behavior of queueing systems in general.

A.1 Birth and Death Equations - Exponential Assumptions

Before we involve ourselves with any particular queueing process, let us discuss a well-known general result for a class of birth and death processes. In particular, we assume that we have a population of units in a system where we allow the population to increase and decrease according to some birth and death coefficients as follows.

Let

$$b_n dt = P_r [\text{birth of a new unit occurs during the time interval } (t, t + dt) \\ \text{given that there were } n \text{ units in the system at time } t]$$

$$d_n dt = P_r [\text{death of an old unit occurs during the time interval } (t, t + dt) \\ \text{given that there were } n \text{ units in the system at time } t]$$

$$o(dt) = P_r [\text{more than one event occurs in } (t, t + dt)]^*$$

where dt is the differential time interval. The assumption here is that the birth and death coefficients, b_n and d_n are independent of time; clearly, they are functions of n , the number already in the system. It is also clear from the assumptions that the system can change only through transitions from states to their nearest neighbors (the system is said to be in state n when there are n units in the system). The boundary condition is that d_0 is identically 0.

Let us further define $P_n(t)$ as follows:

$$P_n(t) = P_r [\text{finding } n \text{ units in the system at time } t]$$

* The notation $o(dt)$ implies that $o(dt)/dt$ approaches zero as dt approaches zero.

With these assumptions and definitions, one can then write down the Chapman-Kolmogorov* equation which then leads to the following differential-difference equations*

$$dP_0(t)/dt = d_1 P_1(t) - b_0 P_0(t)$$

$$dP_n(t)/dt = d_{n+1} P_{n+1}(t) + b_{n-1} P_{n-1}(t) - (d_n + b_n) P_n(t) \quad n \geq 1$$

These equations are known as the forward birth and death equations. The assumption that the birth and death coefficients are independent of time allows one to solve these equations. Specifically, the assumption leads to a distribution of time spent in state n which is exponential, with the exponent $-(b_n + d_n)t$.

Let us now assume the existence of a limiting distribution for $P_n(t)$, that is,

$$\lim_{t \rightarrow \infty} P_n(t) = P_n$$

and furthermore, we consider only those cases (see Feller [13]) for which this limiting distribution is such that

$$\sum_{n=0}^{\infty} P_n = 1$$

We now set all time derivatives equal to zero in the forward equations and obtain a new set of time independent equations, whose solution is

$$P_n = \prod_{i=0}^{n-1} P_0 (b_i / d_{i+1}) \quad (\text{A. 1})$$

The constant P_0 can be determined from

* See Feller [13].

$$P_0 = 1 - \sum_{n=1}^{\infty} P_n$$

Eq. A.1 is the important result, and one of which we shall make considerable use.

A large number of queueing processes can be described in terms of a birth and death process with suitably chosen coefficients, b_n and d_n , as we shall see in the remainder of this appendix (and in the proof of some theorems in Chap. VI).

A.2 Single Exponential Channel*

A queueing process consists of a service facility and a population of units which arrive at this facility and require service. Since the facility may be engaged in servicing another unit when a new unit arrives, one must provide a waiting room (storage) in which arrivals may queue up. Once serviced, a unit leaves the system. In order to properly describe the queueing process, one must specify the following:

- (a) The arrival statistics, in particular, the distribution of the inter-arrival times.
- (b) The service statistics, in particular, the distribution of service times.
- (c) The rules for forming and maintaining the queue (e.g., the maximum number that the storage facility can hold, the queue discipline, etc).
- (d) The number of service facilities.

One can add many other specifications to the list which describe various forms

* Throughout this chapter, as well as in most of this study, we will be concerned with the particular case of messages arriving at a communication center. The service that these messages seek is to be transmitted out of this center to some other center via a communication channel. The server is considered to be busy whenever the communication channel is in use.

of queueing processes. For a reasonably complete list of such variations, the reader is referred to Saaty [17].

For our purposes, let us describe an extremely simple and fundamental queueing process which exhibits the characteristic behavior of a large number of more complicated systems. In particular, we assume the following:

- (a) The inter-arrival times are exponentially distributed with an average arrival rate of λ messages* per second.
- (b) The message lengths are exponentially distributed with an average length of $1/\mu$ bits per message; the channel capacity associated with the transmission facility is C bits per second.
- (c) The queue discipline is first come first served, with an infinite storage capability.
- (d) There is one channel available for transmission.

From these assumptions, one recognizes that the average time required to transmit a message over the channel is $1/\mu C$ seconds. This effectively associates the variable aspect of service with the message rather than with the service facility. This choice differs from the usual assumptions, and, in addition, introduces a new parameter, C . The reason for making this choice is obvious when one considers the physical system

* Throughout this chapter, as well as in most of this study, we will be concerned with the particular case of messages arriving at a communication center. The service that these messages seek is to be transmitted out of this center to some other center via a communication channel. The server is considered to be busy whenever the communication channel is in use.

being discussed.

The assumptions above describe what is known as the single exponential channel.* Its simplicity lies in the assumption of independent exponential distributions for inter-arrival times and message lengths. As is well-known, the exponential distribution is the only continuous distribution which exhibits a complete lack of memory (see Feller [13]).

The quantities of interest in any queueing process are numerous. For our purposes, we are not interested in time-dependent solutions, but rather, we will concentrate on the steady state solutions, where all transient effects have damped out. In particular, we are interested in the following:

- (a) $P_n = P_r$ [n messages in the system] .
- (b) $E(n)$ = Expected value of the number of messages in the system.
- (c) $p(t)dt = P_r$ [total time that a message spends in the system lies in the interval $(t, t + dt)$] .
- (d) T = Expected value of the total time that a message spends in the system.
- (e) $p(> n) = P_r$ [more than n messages in the system] .
- (f) $p(> t) = P_r$ [total time spent in the system is greater than t] .

Whenever we speak of the system, the intent is to include the queue as well as the service facility (the transmission channel in this case).

The solution for any of these quantities involves a new parameter, ρ , which may be defined as follows

* A huge literature has been devoted to the study of the single exponential channel; for example, see Morse [19] or Saaty [17].

$$\rho = \lambda/\mu C \quad (\text{A.2})$$

The parameter ρ is thus the ratio of the average input data rate to the maximum transmission rate. It turns out that ρ is also the fraction of time that the channel is busy, and so it is referred to as the utilization factor. As was stated in the Introduction to this chapter, it is clear that ρ must be less than one if the system is to be capable of handling the flow*. Even with ρ less than one, we still encounter a queueing effect as will be obvious from the equations which follow shortly.

If we desire, we may consider this queueing process to be a birth and death process with coefficients

$$b_n = \lambda$$

$$d_n = \mu C$$

It is then clear from Eq. A.1 that the solution for P_n is, for $\rho < 1$

$$P_n = (1 - \rho)\rho^n \quad (\text{A.3})$$

where we have evaluated P_0 so that the total probability sums to unity.

By perfectly straightforward methods**, one can solve for all quantities of interest listed above; they turn out to be

$$E(n) = \rho/(1 - \rho) \quad (\text{A.4})$$

$$p(t) = \mu C(1 - \rho) e^{-(1-\rho)\mu C t} \quad (\text{A.5})$$

$$T = 1/[\mu C(1 - \rho)] \quad (\text{A.6})$$

$$p(>n) = \rho^{n+1} = e^{-(n+1)[\log C - \log \lambda/\mu]} \quad (\text{A.7})$$

$$p(>t) = e^{-(1-\rho)\mu C t} \quad (\text{A.8})$$

* When $\rho > 1$ then no steady state distributions exist(see Kendall [41]).

**Once again, the reader is referred to Morse [19] or Saaty [17].

From these results, one can observe characteristics of queueing processes in general. The most important observation to make is that the quantity $(1-\rho)$ appears in the denominator of both expected value expressions. Figure A.1 shows $E(n)$ as a function of ρ .

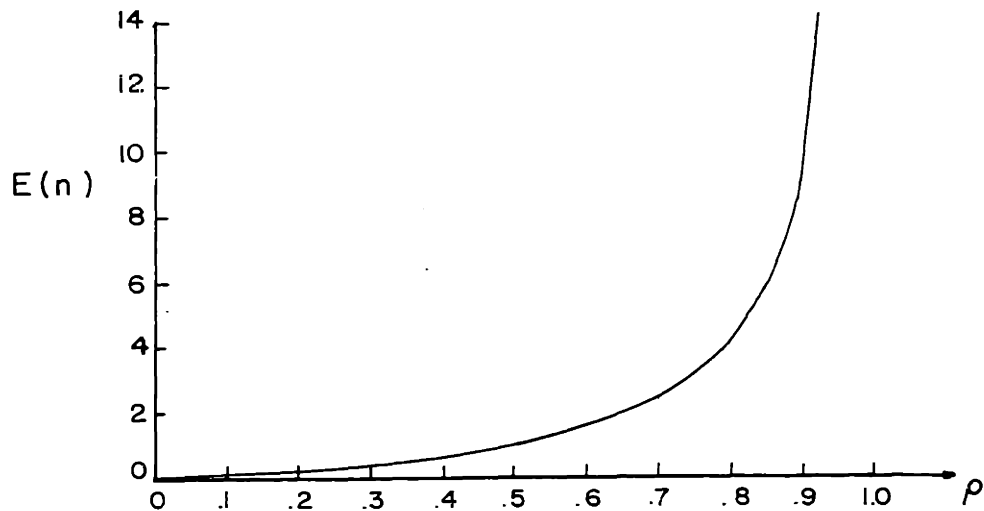

Figure A.1 Expected number of messages in the system for the single exponential channel.

The simple pole at $\rho = 1$ is common in a large number of queueing processes* .

Physically, the reason that the expected number of messages in the system grows without bound as ρ approaches unity is due to the fact that the fluctuations in the input

* For example, in 1951, Kendall [41] showed that for a single channel system identical to the one we have considered, except with an arbitrary distribution of message lengths (with mean lengths $1/\mu C$ and variance σ^2), the expected time that a message spends in the system is

$$T = 1/\mu C + \frac{\rho^2 + \lambda^2 \sigma^2}{2\lambda(1-\rho)}$$

data rate cause the short term average input data rate to vary above and below the long term average; when the long term average approaches the channel capacity (i. e., ρ approaches unity) then the short term variations will sometimes raise the input rate above the channel capacity and thus cause a resultant instability in the queue length.

One also notes that in this simple process, all distributions are either exponential or geometric. It is clear that the parameter ρ plays a central role in all of the results; this is true of other queueing processes as well.

A.3 Multiple Exponential Channels

Instead of a single channel facility as described in Section A.2, let us now consider a similar queueing process with N channels, each of capacity C/N . Thus the total capacity of the service facility is the same as in the single channel case. In addition, the queue discipline is the same as before except when a message gets to the head of the queue, it must take the first available channel. If a message enters the system when more than one channel is free, it chooses one from this set according to a uniform distribution. Otherwise, the assumptions about arrival and service statistics, etc., apply to this case.

The same quantities are of interest here, and once again, we define ρ as the ratio of the average input data rate to the maximum transmission rate:

$$\rho = \lambda/\mu C$$

That is, when all channels are occupied, the transmission rate is C bits per second.

Furthermore, we may consider this queueing process as a birth and death process with coefficients

$$b_n = \lambda$$

$$d_n = \begin{cases} n\mu C/N & n \leq N \\ \mu C & n \geq N \end{cases}$$

It is then clear from Eq. A.1 that the solution for P_n is, for $\rho < 1$

$$P_n = \begin{cases} P_0 \rho^n N^n / n! & n \leq N \\ P_0 \rho^n N^N / N! & n \geq N \end{cases} \quad (\text{A. 9})$$

where

$$P_0 = \left[\sum_{n=0}^{N-1} (N\rho)^n / n! + (N\rho)^N / (1-\rho)N! \right]^{-1} \quad (\text{A. 10})$$

By straightforward methods*, one can solve for the following quantities of interest (defined in Section A.2):

$$P(\geq N) = P_0 (N\rho)^N / (1-\rho)N! \quad (\text{A. 11})$$

$$E(n) = [\rho / (1-\rho)] [N(1-\rho) + P(\geq N)] \quad (\text{A. 12})$$

$$p(t) = \left[\frac{N(1-\rho) - P(<N)}{N(1-\rho) - 1} e^{-(\mu C/N)t} - \frac{N(1-\rho)P(\geq N)}{N(1-\rho) - 1} e^{-(1-\rho)\mu C t} \right] \mu C / N \quad (\text{A. 13})$$

$$T = N/\mu C + P(\geq N)/(1-\rho)\mu C \quad (\text{A. 14})$$

$$p(>t) = \frac{N(1-\rho) - P(<N)}{N(1-\rho) - 1} e^{-(\mu C/N)t} - \frac{P(\geq N)}{N(1-\rho) - 1} e^{-(1-\rho)\mu C t} \quad (\text{A. 15})$$

where

$$P(<N) = 1 - P(\geq N)$$

* See Morse [19] or Saaty [17].

Once again, one notes the central role that the quantity ρ (the utilization factor) plays in all of these expressions. In particular, as ρ approaches unity, the expected number of messages in the system grows without bound, as in the single channel case; this is the situation in most types of queueing processes.

A.4 The Output of a Queueing Process

An interesting theorem which describes the output distribution (i.e., the inter-departure time distribution) from a multiple exponential channel system has been described by Burke [42]. We make use of this theorem in Chap. III and IV. Following is a statement of the theorem (for proof, see Burke [42]).

THEOREM A.1 (due to Burke)

The steady state output of a queue with N channels in parallel, with Poisson arrival statistics, and lengths chosen independently from an exponential distribution, is itself Poisson distributed.

The reasons for presenting the equations for the multiple channel facility should be clear from the area of interest to this research. The problem under consideration involves a network of communication centers. Each center has a number of communication channels connecting it to some other centers; as such, each center begins to resemble the multiple channel service facility. This relationship is discussed in Chaps. III and IV.

APPENDIX B

THEOREMS AND PROOFS FOR CHAPTER IV

B.1 Theorem 4.1 and Its ProofTHEOREM 4.1*

Consider an N channel service facility of total capacity C , with Poisson arrivals (rate λ), and with exponential message lengths (mean length $1/\mu$). Define

$$\rho = \lambda/\mu C$$

Then

$$\rho = 1 - \sum_{n=0}^{\infty} \frac{\bar{C}_n}{C} P_n$$

provided $\rho < 1$. Where,

\bar{C}_n = the average unused capacity given n messages in system

P_n = P_r [n messages in the system]

PROOF:

The system considered satisfies the conditions of the birth-death process examined in Appendix A, with

$$b_n = \lambda$$

$$d_n = \mu(C - \bar{C}_n)$$

Therefore, by Eq. A.1, we find that

* The statement of this theorem is somewhat abbreviated here; full details may be found in Chap. IV.

$$P_n = P_0 \rho^n / \left[\prod_{i=1}^n (1-r_i) \right] \quad (\text{B. 1})$$

where

$$r_i = \bar{C}_i / C$$

Let us solve for P_0 .

$$1 = \sum_{n=0}^{\infty} P_n = P_0 \left[1 + \sum_{n=1}^{\infty} R_n \rho^n \right]$$

where

$$R_n = \frac{1}{n \prod_{i=1}^n (1-r_i)}$$

Thus,

$$P_0 = \frac{1}{1 + \sum_{n=1}^{\infty} R_n \rho^n} \quad (\text{B. 2})$$

Now, according to the statement of the theorem, let us form and solve for

$$x = 1 - \sum_{n=0}^{\infty} \frac{\bar{C}_n}{C} P_n$$

Noting that $\bar{C}_0 = C$ by construction, and using Eqs. B.1 and B.2, we obtain

$$x = 1 - \frac{1 + \sum_{n=1}^{\infty} r_n R_n \rho^n}{1 + \sum_{n=1}^{\infty} R_n \rho^n}$$

$$x = \frac{\sum_{n=1}^{\infty} R_n \rho^n (1-r_n)}{1 + \sum_{n=1}^{\infty} R_n \rho^n}$$

and so, $x = \rho$, which proves the theorem.

B.2 Theorem 4.2 and Its Proof

THEOREM 4.2

The value of N which minimizes T for the system shown in Fig.

4.1, for all $0 \leq \rho < 1$, is

$$N = 1$$

PROOF:

From Eq. A.14, we are given

$$T = \frac{N}{\mu C} \left[1 + \frac{1/N(1-\rho)}{S_N(1-\rho) + 1} \right] \quad (\text{B.3})$$

where

$$S_N = \sum_{n=0}^{N-1} (N\rho)^{n-N} N!/n! > 0$$

now

$$S_N = \sum_{n=0}^{N-1} \rho^{n-N} [N/N] [(N-1)/N] \dots [(n+1)/N]$$

therefore

$$S_N \leq \sum_{n=0}^{N-1} \rho^{n-N} = (\rho^{-N} - 1)/(1-\rho)$$

giving

$$0 < S_N \leq \frac{\rho^{-N} - 1}{1-\rho} \quad (\text{B.4})$$

Now, Eq. (B.3) yields

$$T = 1/\mu C(1-\rho) \quad \text{for } N = 1$$

therefore, it is sufficient to show that

$$T > 1/\mu C(1-\rho) \quad \text{for all } N > 1, \quad 0 \leq \rho < 1$$

using (B.4) we get, for (B.3)

$$T \geq (N/\mu C) [1 + \rho^N / N(1-\rho)]$$

$$T \geq [N(1-\rho) + \rho^N] / \mu C(1-\rho)$$

Letting

$$\alpha = 1 - \rho$$

we see that

$$N(1-\rho) + \rho^N = N\alpha + (1-\alpha)^N \geq N\alpha + 1 - N\alpha = 1$$

Thus,

$$T \geq \frac{1}{\mu C(1-\rho)}$$

for all N , and in particular, the only case for which the equality holds is for $N = 1$.

Note that the equality would also hold for $\alpha = 0$ but this implies that $\rho = 1$, which we do not permit. Thus

$$T > \frac{1}{\mu C(1-\rho)} \quad \text{for } N > 1 \text{ and } 0 \leq \rho < 1$$

which completes the proof.

B.3 Theorems 4.3, 4.5, and 4.6, and Their Proofs

For purposes of proof only, we consider a more general case (similar to Theorem 4.6) in which we allow an arbitrary set of μ_i (whereas Theorem 4.6, in its original form requires that $\mu_i = \mu$ for all i , in order to obtain a proper physical interpretation). After proving this more general case, we observe that Theorem 4.3 is the special case wherein $D = C$ and $d_i = 1$ for all i ; Theorem 4.5 is the special

case wherein $D = C$, $d_i = 1$, and $\mu_i = \mu$ for all i ; and Theorem 4.6 is the special case wherein $\mu_i = \mu$ for all i . Thus, we prove the three theorems simultaneously.

Accordingly, we first state this more general theorem below (for purposes of proof only).

THEOREM

Consider a communication net with N channels such as described for Theorem 4.6, in which we now allow an arbitrary set of μ_i . The assignment of channel capacity C_i , to the i^{th} channel, which minimizes T subject to the constraint

$$\sum_{i=1}^N C_i d_i = D \quad (\text{B.5})$$

is

$$C_i = \frac{\lambda_i}{\mu_i} + \left(\frac{D_e}{d_i} \right) \frac{\sqrt{\lambda_i d_i / \mu_i}}{\sum_{j=1}^N \sqrt{\lambda_j d_j / \mu_j}} \quad (\text{B.6})$$

With this optimum assignment,

$$T_i = \frac{\sum_{j=1}^N \sqrt{\lambda_j d_j / \mu_j}}{D_e \sqrt{\lambda_i \mu_i / d_i}} \quad (\text{B.7})$$

and

$$T = \frac{\bar{n} \left(\sum_{i=1}^N \sqrt{\frac{\lambda_i d_i}{\lambda \mu_i}} \right)^2}{D_e} \quad (\text{B.8})$$

provided

$$D_e > 0$$

and where

$$D_e = D - \sum_{j=1}^N \frac{\lambda_j d_j}{\mu_j}$$

and

$$\bar{n} = \frac{\lambda}{\gamma} \tag{B. 9}$$

PROOF:

We recognize, from Eq. 4.17, that

$$T = \sum_{i=1}^N \frac{\lambda_i}{\gamma} T_i$$

As discussed in Sect. 4.4, we find that the Independence Assumption allows us to write

T_i as (see also Eq. A.6),

$$T_i = \frac{1}{\mu_i C_i - \lambda_i}$$

With these expressions, we now form the Lagrangian* G as follows.

$$G = T + \alpha \left[\sum_{i=1}^N C_i d_i - D \right]$$

Differentiating G with respect to C_i , and setting this result equal to zero, we obtain

$$0 = - \frac{\lambda_i}{\gamma} \frac{\mu_i}{(\mu_i C_i - \lambda_i)^2} + \alpha d_i$$

or

$$C_i = \frac{\lambda_i}{\mu_i} + \frac{1}{\sqrt{\alpha \gamma}} \sqrt{\frac{\lambda_i}{\mu_i d_i}} \tag{B. 10}$$

* See Hildebrand [43].

Multiplying Eq. B. 10 by d_i and summing on i , we find

$$\sum_{i=1}^N C_i d_i = D = \sum_{i=1}^N \frac{\lambda_i d_i}{\mu_i} + \frac{1}{\sqrt{\alpha\gamma}} \sum_{i=1}^N \sqrt{\frac{\lambda_i d_i}{\mu_i}}$$

from which we obtain

$$\frac{1}{\sqrt{\alpha\gamma}} = \frac{D - \sum_{i=1}^N \frac{\lambda_i d_i}{\mu_i}}{\sum_{i=1}^N \sqrt{\frac{\lambda_i d_i}{\mu_i}}} \quad (\text{B. 11})$$

Substituting Eq. B. 11 into Eq. B. 10, we arrive at

$$C_i = \frac{\lambda_i}{\mu_i} + \left(\frac{D}{d_i} \right) \frac{\sqrt{\lambda_i d_i / \mu_i}}{\sum_{j=1}^N \sqrt{\frac{\lambda_j d_j}{\mu_j}}}$$

which establishes Eq. B. 6.

If we now substitute Eq. B. 6 into our expression for T_i , we obtain

$$T_i = \frac{1}{\mu_i \left[\frac{\lambda_i}{\mu_i} + \left(\frac{D}{d_i} \right) \frac{\sqrt{\lambda_i d_i / \mu_i}}{\sum_{j=1}^N \sqrt{\frac{\lambda_j d_j}{\mu_j}}} \right]} - \lambda_i$$

or

$$T_i = \frac{\sum_{j=1}^N \sqrt{\lambda_j d_j / \mu_j}}{D_e \sqrt{\lambda_i \mu_i / d_i}}$$

This establishes Eq. B. 7.

Furthermore, substituting Eq. B. 7 into our expression for T gives us

$$T = \sum_{i=1}^N \frac{\lambda_i}{\gamma} T_i = \sum_{i=1}^N \frac{\lambda_i}{\gamma} \frac{\sum_{j=1}^N \sqrt{\lambda_j d_j / \mu_j}}{D_e \sqrt{\lambda_i \mu_i / d_i}}$$

or

$$T = \frac{\bar{n} \left(\sum_{i=1}^N \sqrt{\frac{\lambda_i d_i}{\lambda \mu_i}} \right)^2}{D_e}$$

This establishes Eq. B.8.

In order to show that $\bar{n} = \lambda/\gamma$, we observe that \bar{n} may be written as

$$\bar{n} = \sum_{j,k} \frac{\gamma_{jk}}{\gamma} n_{jk} \quad (\text{B.12})$$

where n_{jk} is the path length for the origin-destination pair jk . Now, we recognize that λ_i is the sum of all γ_{jk} for which the jk route includes channel i . If we consider λ (i.e., the sum of the λ_i by definition), we observe that λ is composed of the numbers γ_{jk} , each added in n_{jk} times. That is,

$$\lambda = \sum_i \lambda_i = \sum_{j,k} \gamma_{jk} n_{jk} \quad (\text{B.13})$$

If we now substitute Eq. B.13 into Eq. B.12, we obtain

$$\bar{n} = \frac{\lambda}{\gamma}$$

which establishes Eq. B.9, and completes the proof of the theorem stated above.

We observe that setting $\mu_i = \mu$ for all i (in the theorem above) establishes Theorem 4.6. For Theorems 4.3 and 4.5, we take $D = C$ and $d_i = 1$ for all i ; we observe that under these conditions,

$$\begin{aligned}
 D_e &= C - \sum_{j=1}^N \frac{\lambda_j}{\mu_j} \\
 &= C - \lambda \sum_{j=1}^N \frac{\lambda_j}{\lambda} \frac{1}{\mu_j}
 \end{aligned}$$

From the definition of $1/\mu$ and ρ given in Sect. 1.5, and from the expression for \bar{n} in Eq. B.9, we find that

$$D_e = C - \frac{\lambda}{\mu}$$

or

$$D_e = C(1 - \bar{n}\rho)$$

Using this expression for D_e in the theorem as stated in this appendix, and noting that $\bar{n} = 1$ for the conditions of Theorem 4.3, we prove Theorem 4.3. By setting $\mu_i = \mu$ and using the expression above for D_e , we further establish Theorem 4.5.

B.4 Theorem 4.4 and Its Proof

THEOREM 4.4

The distribution of λ_i which minimizes T in Theorem 4.3, subject to the constraints expressed by Eqs. 4.6 and 4.13 is, for $\mu_i = \mu$,

$$\lambda_i = \begin{cases} \lambda - \sum_{j=2}^N k_j & i=1 \\ k_i & i=2, 3, \dots, N \end{cases}$$

PROOF:

We note that minimizing Eq. 4.12, with $\mu_i = \mu$, is equivalent to minimizing the

sum S ,

$$S = \sum_{i=1}^N \sqrt{\lambda_i}$$

We prove the theorem by showing that if any λ_i (say λ_j) is of the form

$$\lambda_j = k_j + \alpha_j$$

where $\alpha_j > 0$, then S will not be increased by the new assignment

$$\lambda'_j = k_j$$

$$\lambda'_1 = \lambda_1 + \alpha_j$$

where $j \geq 2$.

Specifically, we wish to show that for

$$S' = \sum_{\substack{i=2 \\ i \neq j}}^N \sqrt{\lambda_i} + \sqrt{\lambda'_1} + \sqrt{\lambda'_j}$$

then

$$S' \leq S$$

where the prime notation indicates a single change of the form described above. We must therefore show that

$$\sqrt{\lambda'_1} + \sqrt{\lambda'_j} \leq \sqrt{\lambda_1} + \sqrt{\lambda_j}$$

or

$$\sqrt{\lambda_1 + \alpha_j} + \sqrt{k_j} \leq \sqrt{\lambda_1} + \sqrt{k_j + \alpha_j}$$

Since both sides of this last inequality are positive, we may square each side to obtain as our condition,

$$\lambda_1 + \alpha_j + k_j + 2\sqrt{(\lambda_1 + \alpha_j)k_j} \leq \lambda_1 + k_j + \alpha_j + 2\sqrt{\lambda_1(k_j + \alpha_j)}$$

Once again, due to the positiveness of these quantities, we obtain, after cancellation and squaring,

$$k_j \leq \lambda_1 \tag{B.14}$$

Equation B.14 must be satisfied for our theorem to hold. Now, by Eq. 4.14, we have

$$k_j \leq k_1$$

But, by definition,

$$\lambda_1 = k_1 + \alpha_1$$

where $\alpha_1 \geq 0$. Thus, we obtain

$$k_j \leq k_1 \leq \lambda_1$$

which establishes Eq. B.14, and proves the theorem.

We note that if $\alpha_1 = 0$ and $k_j = k_1$, then $S' = S$; otherwise, $S' < S$. Thus, if more than one $\lambda_j = k_j + \alpha_j$ where $\alpha_j > 0$, then surely $S' < S$ after making all these changes successively.

APPENDIX C

THEOREMS AND PROOFS FOR CHAPTER V

We make extensive use of a well-known result in queueing theory throughout this appendix. The result was conjectured by many researchers, and recently, a formal proof of its validity was published by Little [44]. Roughly stated, the result says that the expected number, $E(n)$, of units in a queueing system which has reached equilibrium, is equal to the product of input rate, λ of these units to the system, and the expected value, τ , of the time spent by these units in the system, i. e. ,

$$E(n) = \lambda\tau \quad (\text{C. 1})$$

Certain weak restrictions are placed upon the queueing process, but these need not concern us since all the systems with which we deal satisfy these conditions.

The definition of system in this equality is left unspecified, and so, we may choose to define it as the queue itself, in which case we use the notation $\tau = W$; or we may choose to define it as the system which includes both the queue and the service facility, in which case we use the notation $\tau = T$. In addition, we may choose to separate the units in the system into a set of subgroups, in which case, the equality above holds for each subgroup separately (i. e. , labeling the p^{th} subgroup by the subscript p , we have $E(n_p) = \lambda_p \tau_p$ where τ_p may take the form W_p or T_p , depending upon the choice of the definition of the system).

Most of the proofs of the priority queueing results are based upon arguments concerning expected values. In such cases, the random variables involved are usually suppressed. In order to offer one example of the complete derivation involving the random variables, the proof of the Conservation Law is carried out

in its entirety. This complete procedure leads naturally to Eq. C.5 involving only expected values which could have been written down immediately if originally one were to argue on an expected value basis. Therefore, except for this one example, most of the other proofs are carried out using expected values only, since the random variable arguments for all proofs are so similar.

Many of the theorems proven in this Appendix involve the assumption that service times (i.e., message lengths) are chosen independently from some exponential distribution. It is well-known* that an exponential distribution is the only continuous distribution with a Markovian character, i.e., it is memoryless. By this we mean that if, for a nonnegative random variable x

$$P_r[x \geq t] = e^{-\mu t}$$

then for $t \geq t_0 \geq 0$

$$P_r[x \geq t \mid x \geq t_0] = e^{-\mu(t-t_0)} \quad (\text{C.2})$$

This property is easily checked by carrying out the calculation, and we make extensive use of it.

We find it convenient to derive the theorems in this Appendix in an order different from that presented in Chapter V. In particular, we first prove the Conservation Law (and its related corollaries) and then proceed as in Chapter V.

* See, for example, Feller [13, Sect. XVII.6].

C.1 The Conservation Law (Theorem 5.4) and its proof

THEOREM 5.4

For any queue discipline and any fixed arrival and service time distributions which fall in the class defined in Sect. 5.2,

$$\sum_{p=1}^P \rho_p W_p = \begin{cases} \frac{\rho}{1-\rho} V_1 & 0 \leq \rho < 1 \\ \infty & \rho \geq 1 \end{cases}$$

where

$$V_1 = 1/2 \sum_{p=1}^P \lambda_p E(t_p^2)$$

and

$$E(t_p^2) = \text{second moment of service time distribution for group } p.$$

PROOF:

Let us define $U(t)$ as the total unfinished work present in the system at time t . In particular, $U(t)$ represents the time that it would take to empty the system of all messages present at time t , if no new messages (units)* were allowed to enter the system after time t . A typical section of $U(t)$ might look like the graph shown in Fig. C.1.

The instants t_i are the times of arrival (independent and Poisson) of new units to the system, each unit having its service time, v_i chosen independently from some distribution. The $U(t)$ function decreases at a steady rate of one sec/sec as long as

* The terms "message" and "unit" are used interchangeably in this appendix.

$U(t)$ is positive; it jumps by v_i at the times t_i , and once having reached zero, it remains there until the next unit's arrival. Now, it is clear, that the following limit is well-defined (and exists whenever $\rho < 1$ for the system under consideration):

$$\bar{W} = \lim_{T \rightarrow \infty} \frac{1}{T} \int_0^T U(t) dt$$

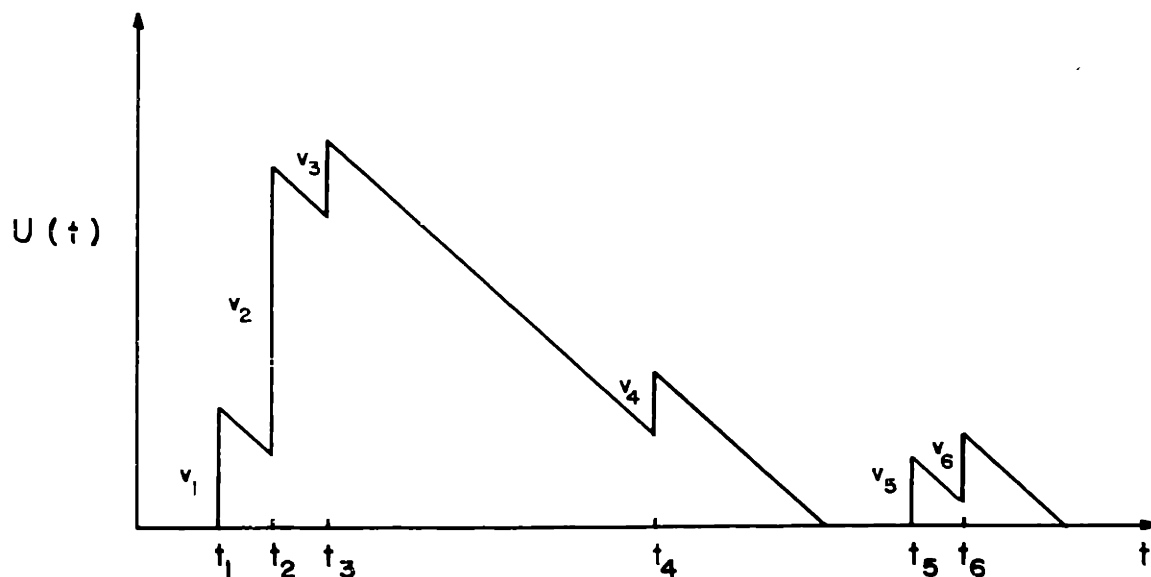

Figure C.1 Total unfinished work, $U(t)$, in the system.

Thus \bar{W} is defined as the average value of $U(t)$.

Let us restrict the class of queueing systems that we consider to those which satisfy the conditions set forth in Sect. 5.2. Under these restrictions, it is clear that no matter what discipline is used (priority, pre-emption, or what have you), as long as the same set of t_i and v_i are involved, the function $U(t)$ will be the same. It is further obvious, that no matter which $U(t)$ function turns up, as long as the same

statistics are used for the t_i and v_i , the expected value, \bar{W} , of the unfinished work will be the same.

One recognizes that the expected value of the waiting time (in queue only) for a unit in a strict first come first serve discipline is just \bar{W} (i.e., the waiting time is exactly equal to the unfinished work in a first come first serve system). Now, in view of the independence of \bar{W} to the particular discipline used, we proceed to calculate \bar{W} for a strict first come first serve discipline; the calculation consists of deriving an expression for the expected value of the waiting time (in queue) since we have seen that this value is just \bar{W} itself. We consider first, the case $0 \leq \rho < 1$.

Accordingly, let the random variable w represent the waiting time (in queue) of an arbitrary unit (the tagged unit). In addition, let there be n_p type p units present in the queue upon the arrival of the tagged unit; also, let t_{ip} represent the time spent in service by the i^{th} unit ($i=1, 2, \dots, n_p$) of type p . Further, let t_0 be the time required to complete service on the unit found in service upon the arrival of the tagged unit. Thus, w may be written as

$$w = t_0 + \sum_{p=1}^P \sum_{i=1}^{n_p} t_{ip} \quad (\text{C. 3})$$

We have separated the units in the system into P classes. This is done in anticipation of applying the result of this derivation to priority systems, etc., which have P classes of units. Now, w, t_0, t_{ip}, n_p are all random variables. Let us next form the expected value* on both sides of Eq. C. 3:

* Note that Eq. C. 3 is capable of yielding more relationships of the type stated in Eq. 5.18. These may be obtained by first raising Eq. C. 3 to the n^{th} power and then taking expected values. The author expects to pursue this line of investigation.

$$\bar{W} = V_1 + \sum_{p=1}^P \sum_{n_p=0}^{\infty} r(n_p) \sum_{i=1}^{n_p} E(t_{ip}) \quad (\text{C.4})$$

where clearly*, $E(t_0) = V_1$ and $r(n_p)$ is the probability that n_p type p units are present in the queue upon the arrival of the tagged unit. We define,

$$E(t_{ip}) = \frac{1}{\mu_p}$$

where all service times for type p units are chosen independently from the same distribution (not necessarily exponential) whose mean is $\frac{1}{\mu_p}$. Thus, Eq. C.4

becomes

$$\bar{W} = V_1 + \sum_{p=1}^P \frac{1}{\mu_p} \sum_{n_p=0}^{\infty} n_p r(n_p)$$

Now, from Eq. C.1, we recognize that

$$\sum_{n_p=0}^{\infty} n_p r(n_p) = \lambda_p W_p$$

where λ_p and W_p are consistent with their definitions used earlier in this thesis.

Thus we arrive at the following form for \bar{W} :

$$\bar{W} = V_1 + \sum_{p=1}^P \rho_p W_p \quad (\text{C.5})$$

Let us recall, now, that we are dealing with a strict first come first serve discipline

* Equation 5.19, which gives an explicit expression for V_1 , has been derived by a number of authors; for example, a simple derivation may be found in Saaty [17, Sect. 11-2.1a].

with Poisson input traffic; this implies that all waiting times, W_p are equal, and in particular, $W_p = \bar{W}$ for all p . Thus, we convert Eq. C.5 to

$$\bar{W} = \frac{V_1}{1-\rho} \quad (\text{C.6})$$

Substituting the value of \bar{W} , as given by Eq. C.6, into Eq. C.5, we obtain

$$\sum_{p=1}^P \rho_p W_p = \frac{\rho}{1-\rho} V_1$$

which establishes Eq. 5.18 for $0 \leq \rho < 1$.

For the case $\rho \geq 1$ we need only recognize that the input traffic rate exceeds* the service rate in which case we see immediately that at least one of the W_p (where $\rho_p > 0$) grows without bound. Of course, in such a case, we have no steady state solution. This completes the proof of the conservation law.

It is convenient to digress at this point in order to illustrate a simple method of establishing the result

$$V_1 = \sum_{p=1}^P \rho_p / \mu_p$$

for exponentially distributed service times. Let us define T_p as equal to $W_p + \frac{1}{\mu_p}$. Also define $\frac{1}{\mu'_p}$ as the expected value of the additional time required by a unit of type p , given that this unit was still in the system at an arbitrary instant of time. Accordingly, the expected value of the unfinished work is

$$\bar{W} = \sum_{p=1}^P \frac{\lambda_p T_p}{\mu'_p} \quad (\text{C.7})$$

* For $\rho \rightarrow 1$, we note that $\frac{\rho}{1-\rho} V_1$ approaches ∞ . The limiting case for $\rho = 1$ is discussed fully by Lindley [45].

where, once again, we have used Eq. C.1. Taking advantage of the memoryless property of exponential distributions as discussed previously (see Eq. C.2), we come to the conclusion that

$$\frac{1}{\mu'_p} = \frac{1}{\mu_p}$$

Using this, as well as the substitution $T_p = W_p + \frac{1}{\mu_p}$ in Eq. C.7 we find that

$$\bar{W} = \sum_{p=1}^P \frac{\rho_p}{\mu_p} + \sum_{p=1}^P \rho_p W_p$$

Comparing this to Eq. C.5, we conclude that, for exponential service times,

$$V_1 = \sum_{p=1}^P \rho_p / \mu_p$$

It is now clear where the definition $W_0 (= V_1)$ came from in Sect. 5.1.

C.2 Corollaries to the Conservation Law, and their Proof

There exist priority disciplines for which $\rho \geq 1$ and a subclass of the priority groups obtain a bounded steady state solution for W_p . In particular, this is true for the fixed priority systems studied in Sect. 5.1. If we consider the fixed priority systems with $0 \leq \rho$, we expect that some of the W_p may grow without bound; let us label this set with the indices $p=1, 2, \dots, j-1$. For $p=j, j+1, \dots, P$ we expect* bounded W_p .

* Once again, the reader is referred to Phipps [34].

The conservation law holds, of course, but we wonder what constraints on the waiting time may exist for those groups with $p \geq j$. We express these constraints in the following two corollaries.

COROLLARY 1

For $0 \leq \rho$ and a fixed priority discipline with no pre-emption, and under restrictions a, b, and d as expressed in Sect. 5.2,

$$\sum_{p=j}^P \rho_p W_p = \frac{s_j}{1-s_j} (V_j + V'_j) \quad (\text{C. 8})$$

where

$$V_j = \frac{1}{2} \sum_{p=j}^P \lambda_p E(t_p^2) \quad (\text{C. 9})$$

$$V'_j = \frac{f}{2} \lambda_{j-1} E(t_{j-1}^2) \quad (\text{C. 10})$$

$j =$ smallest positive integer such that $\sum_{p=j}^P \rho_p < 1$

$$s_j = \sum_{p=j}^P \rho_p \quad (\text{C. 11})$$

and

$$f = \begin{cases} 0 & \rho < 1 \\ \frac{1-s_j}{\rho_{j-1}} & \rho \geq 1 \end{cases} \quad (\text{C. 12})$$

PROOF:

Let

$$U_j = E [\text{remaining work in system to be done on classes } j, j+1, \dots, P]$$

$$V_j = E [\text{remaining work in the service facility to be done on classes } j, j+1, \dots, P]$$

$$V'_j = E [\text{remaining work in the service facility to be done on class } j-1].$$

$f\rho_{j-1}$ = fraction of time that a unit from class $j-1$ is in the service facility.

Now, considering a nonpre-emptive fixed priority system, and following the same type of argument that led to Eq. C.5, we see that

$$U_j = V_j + \sum_{p=j}^P \rho_p W_p \quad (\text{C. 13})$$

We now wish to evaluate U_j . U_j will be invariant to any priority structure within the classes $j, j+1, \dots, P$, for the same reasons that \bar{W} was invariant in the case $\rho < 1$.

Taking advantage of this, we evaluate U_j by setting up the following simplified priority structure. Let all units in the classes $j, j+1, \dots, P$ follow a first come first served discipline among themselves; however, they join the queue in front of all units of priority $j-1$ or less. In such a case, for $p \geq j$, we can write

$$W_p = U_j + V'_j$$

That is, the time spent in the queue will be U_j (due to the first come first serve structure) plus the time required to complete the unit found in service if that unit is from class $j-1$ (since if the unit in service is from class $\geq j$, this additional time

is accounted for in U_j). Thus Eq. C.13 becomes

$$U_j = V_j + \sum_{p=j}^P \rho_p U_j + \sum_{p=j}^P \rho_p V'_j \quad (\text{C.14})$$

and so

$$U_j = \frac{V_j + s_j V'_j}{1 - s_j} \quad (\text{C.15})$$

where

$$s_j = \sum_{p=j}^P \rho_p$$

and so, equating Eq. C.13 and Eq. C.15, we get

$$\sum_{p=j}^P \rho_p W_p + V_j = \frac{V_j + s_j V'_j}{1 - s_j}$$

yielding

$$\sum_{p=j}^P \rho_p W_p = \frac{s_j}{1 - s_j} (V_j + V'_j)$$

Due to the Poisson input statistics, we may apply the result that Cobham [35] and Phipps [34] obtained*, i. e.,

$$V_j = \frac{1}{2} \int_0^{\infty} t^2 \sum_{p=j}^P \lambda_p dF_p(t) = \frac{1}{2} \sum_{p=j}^P \lambda_p E(t_p^2)$$

and

$$V'_j = \frac{f}{2} \int_0^{\infty} t^2 \lambda_{j-1} dF_{j-1}(t) = \frac{f}{2} \lambda_{j-1} E(t_{j-1}^2)$$

* The cumulative distribution function for the service time of the p^{th} priority group is denoted by $F_p(t)$.

Also, we notice that $f\rho_{j-1}$, the fraction of time that type $(j-1)$ units utilize the service facility, may be calculated as

$$f\rho_{j-1} = 1-s_j \quad \text{for } \rho \geq 1$$

and so

$$f = \frac{1-s_j}{\rho_{j-1}} \quad \text{for } \rho \geq 1 \text{ (or } j > 1)$$

and for completeness, we define

$$f = 0 \quad \text{for } \rho < 1 \text{ (} j=1)$$

With these substitutions, we note that for the case $\rho < 1$, we obtain the same result as given in Eq. 5.18 which, of course, we must.

This completes the proof of Corollary 1.

COROLLARY 2

For a fixed priority discipline with pre-emptive resume, exponential service time distributions, and under restrictions a, b, and d as expressed in Sect. 5.2,

$$\sum_{p=j}^P \rho_p W_p = \frac{s_j}{1-s_j} V_j \quad (\text{C. 16})$$

PROOF:

We now show how an equation similar to Eq. C.8 may be obtained for a pre-emptive resume situation with exponentially distributed service times. Clearly,

Eq. C.13 still holds. In order to evaluate U_j , we now use the same trick as for the nonpre-emption case (i.e., form all priority groups into two groups -- the first group consisting of classes $j, j+1, \dots, P$ and all others being in the second group) except we allow members of the first group to pre-empt units from the second group. Then we see that, for $p \geq j$,

$$W_p = U_j$$

and so, Eq. C.13 becomes

$$U_j = V_j + \sum_{p=j}^P \rho_p U_j$$

or

$$U_j = \frac{V_j}{1 - s_j} \tag{C.17}$$

Substituting Eq. C.17 into Eq. C.13 yields

$$\frac{V_j}{1 - s_j} = V_j + \sum_{p=j}^P \rho_p W_p$$

or

$$\sum_{p=j}^P \rho_p W_p = \frac{s_j}{1 - s_j} V_j$$

Once again, V_j is as given previously. Note also that for $j = 1$, Eq. C.16 reduces to Eq. 5.18. This completes the proof of Corollary 2.

We note here that in the case of exponentially distributed service times, we

obtain

$$V_j = \sum_{p=j}^P \rho_p / \mu_p$$

and so we recognize that $V_1 = W_0$ as defined in Sect. 5.1.

C.3 Theorem 5.1 and its proof

THEOREM 5.1

For a fixed priority system with pre-emption, and $0 \leq \rho$,

$$W_p = \begin{cases} \frac{\frac{\rho_p}{\mu_p} + \sum_{i=p+1}^P \rho_i \left(\frac{1}{\mu_p} + \frac{1}{\mu_i} \right) + \sum_{i=p+1}^P \rho_i W_i}{1 - \sum_{i=p}^P \rho_i} & p \geq j \\ \infty & p < j \end{cases}$$

or

$$W_p = \begin{cases} \frac{\frac{s_j}{1-s_j} \sum_{i=j}^P \rho_i / \mu_i + \frac{\rho_p}{\mu_p} + \sum_{i=p+1}^P \rho_i \left(\frac{1}{\mu_p} + \frac{1}{\mu_i} \right) - \sum_{i=j}^{p-1} \rho_i W_i}{1 - \sum_{i=p+1}^P \rho_i} & p \geq j \\ \infty & p < j \end{cases}$$

where j is as defined in Cobham's result, and

$$s_j = \sum_{i=j}^P \rho_i$$

PROOF:

We argue on the basis of expected values in proving this theorem. Let

$$T_i = \text{Expected time that a message from priority class } i \text{ spends} \\ \text{in the system (queue plus service time)}$$

The expected time T_p for a unit (the tagged unit, say) from priority class p is composed of three terms: its expected time in service; the expected time to service units (with as high or higher priority) present at the time of arrival; and, the expected time to service units (with higher priority) which enter the system while the tagged unit is still in the system*. The expected number of messages from the i^{th} priority group which are present at the time of arrival of the tagged unit is, by Eq. C. 1, $\lambda_i T_i$. The expected number of messages from the i^{th} priority group which arrive during the time that the tagged unit remains in the system is, by consideration of Poisson arrival statistics, $\lambda_i T_p$. We collect these statements in the following equation, where we assume $0 \leq \rho < 1$,

$$T_p = \frac{1}{\mu_p} + \sum_{i=p}^P \frac{1}{\mu_i} \lambda_i T_i + \sum_{i=p+1}^P \frac{1}{\mu_i} \lambda_i T_p \quad (\text{C. 18})$$

Now, clearly,

$$W_i = T_i - \frac{1}{\mu_i}$$

* Recall that units within the same priority class are served in a first come first served fashion.

and so Eq. C.18 becomes

$$W_p = \sum_{i=p}^P \rho_i \left(W_i + \frac{1}{\mu_i} \right) + \sum_{i=p+1}^P \rho_i \left(W_p + \frac{1}{\mu_p} \right).$$

Solving this, we obtain, for $0 \leq \rho < 1$,

$$W_p = \frac{\frac{\rho_p}{\mu_p} + \sum_{i=p+1}^P \rho_i \left(\frac{1}{\mu_p} + \frac{1}{\mu_i} \right) + \sum_{i=p+1}^P \rho_i W_i}{1 - \sum_{i=p}^P \rho_i}$$

Now, for $\rho \geq 1$ we expect stable behavior only for $p \geq j$ where $j =$ smallest positive integer such that $\sum_{i=j}^P \rho_i < 1$ (see Phipps [34]). The derivation above will now apply only for $p \geq j$ and in the case $p < j$, we have $W_p = \infty$. Noting this, we see that we have proven Eq. 5.9 of Theorem 5.1.

We now establish Eq. 5.10. Observe that

$$\sum_{i=p+1}^P \rho_i W_i = \sum_{i=j}^P \rho_i W_i - \sum_{i=j}^p \rho_i W_i$$

Now, using Corollary 2, we get

$$\sum_{i=p+1}^P \rho_i W_i = \frac{s_j}{1-s_j} \sum_{i=j}^P \rho_i / \mu_i - \sum_{i=j}^p \rho_i W_i.$$

Using this last expression in Eq. 5.9 yields, for $p \geq j$

$$W_p = \frac{\frac{s_j}{1-s_j} \sum_{i=j}^P \rho_i / \mu_i + \frac{\rho_p}{\mu_p} + \sum_{i=p+1}^P \rho_i \left(\frac{1}{\mu_p} + \frac{1}{\mu_i} \right) - \sum_{i=j}^{p-1} \rho_i W_i}{1 - \sum_{i=p+1}^P \rho_i}$$

which establishes Eq. 5.10 of Theorem 5.1.

C.4 Theorem 5.2 and its proof

THEOREM 5.2

For the delay dependent priority system with no pre-emption, and

$$0 \leq \rho < 1,$$

$$W_p = \frac{\frac{W_0}{1-\rho} - \sum_{i=1}^{p-1} \rho_i W_i \left(1 - \frac{b_i}{b_p} \right)}{1 - \sum_{i=p+1}^P \rho_i \left(1 - \frac{b_p}{b_i} \right)}$$

or

$$W_p = \frac{W_0}{1-\rho} \left(\frac{1}{D_p} \right) \left[1 + \sum_{j=1}^{p-1} \sum_{0 < i_1 < i_2 < \dots < i_j < p} F_{i_1}(i_2) F_{i_2}(i_3) \dots F_{i_j}(p) \right]$$

where

$$D_p = 1 - \sum_{i=p+1}^P \rho_i \left(1 - \frac{b_p}{b_i} \right)$$

and

$$F_k(n) = - \frac{\rho_k}{D_k} \left(1 - \frac{b_k}{b_n} \right)$$

PROOF:

We now establish Eq. 5.12 in which the priority for a unit which is assigned a parameter b_p ($0 \leq b_1 \leq \dots \leq b_p$), is calculated at time t as follows:

$$q_p(t) = (t - T)b_p$$

where T is the time of arrival of the unit. We refer to such a unit as being of type p .

Consider the arrival of a type p unit, which we refer to as the tagged unit.

Upon its arrival, the expected number, $E(n_i)$, of type i units present in the queue, is, by Eq. C.1

$$E(n_i) = \lambda_i W_i.$$

Let f_{ip} represent the expected fraction of these type i units which receive service before the tagged unit does. As usual, W_p will represent the expected value of the time that the tagged unit spends in the queue. We know, by assumption, that the expected number, $E(m_i)$, of type i units which arrive during the time interval W_p , is

$$E(m_i) = \lambda_i W_p.$$

That this is so is obvious from the definition of λ_i as the average number of type i arrivals per second, in addition to the independence of arrival times. Let g_{ip} represent the expected fraction of these type i units which receive service before the tagged unit does. Further, let us define W_0 as we have in the past, namely, the expected

value of the time required to complete service on the unit found in service upon entry.

With these observations and definitions, we are able to write down a set of P simultaneous equations, one for each value of p , as follows:

$$W_p = W_0 + \sum_{i=1}^P \frac{\lambda_i W_i}{\mu_i} f_{ip} + \sum_{i=1}^P \frac{\lambda_i W_p}{\mu_i} g_{ip} \quad (\text{C. 19})$$

The typical term in these sums is of the form: the expected number of type i units which get service before the tagged unit does, times the quantity $1/\mu_i$ which is the expected value of the service time for a type i unit.

Now from the definition of the f_{ij} and g_{ij} , as well as the imposed queue discipline, we note that

$$f_{ip} = 1 \quad \text{for all } i \geq p$$

and

$$g_{ip} = 0 \quad \text{for all } i \leq p$$

Using this information and solving for W_p in Eq. C.19, we obtain

$$W_p = \frac{W_0 + \sum_{i=p}^P \rho_i W_i + \sum_{i=1}^{p-1} \rho_i W_i f_{ip}}{1 - \sum_{i=p+1}^P \rho_i g_{ip}} \quad (\text{C. 20})$$

Let us now derive an expression for g_{ip} . Once again consider the arrival of a p type unit, the tagged unit, at time 0. Since W_p is its expected waiting time, the expected value of its attained priority at the expected time it is accepted for service is $b_p W_p$, as shown in Fig. C.2.

In looking for g_{ip} , we must calculate how many i type units arrive on the average, after time 0 and reach a priority of at least $b_p W_p$ before time W_p . It is obvious from the figure that type i units which arrive in the time interval $(0, V_i)$ will satisfy these conditions. Thus, let us calculate the value of V_i . Clearly,

$$b_p W_p = b_i (W_p - V_i)$$

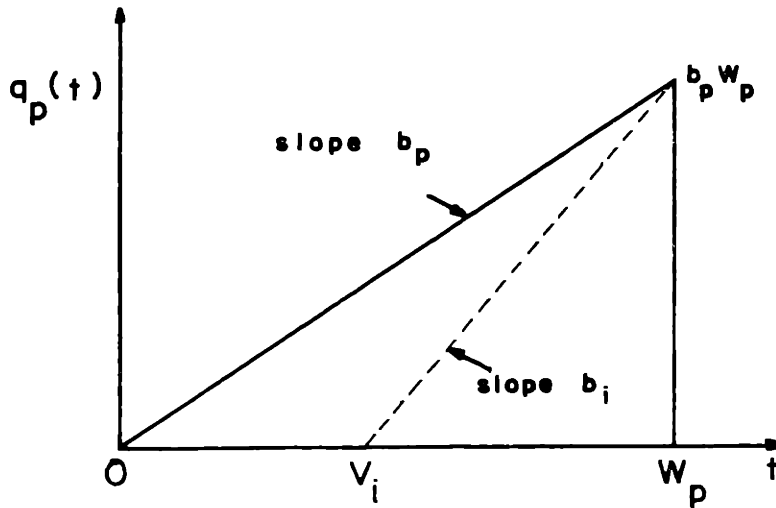

Figure C.2 Diagram of priority, $q_p(t)$, for obtaining g_{ip} .

and so,

$$V_i = W_p \left(1 - \frac{b_p}{b_i} \right)$$

Therefore, with an input rate of λ_i for the type i units, we find that

$$g_{ip} E(m_i) = \lambda_i V_i$$

and so,

$$g_{ip} \lambda_i W_p = \lambda_i W_p \left(1 - \frac{b_p}{b_i} \right)$$

giving

$$g_{ip} = 1 - \frac{b_p}{b_i} \quad \text{for all } i > p$$

We now prove that $f_{ip} = \frac{b_i}{b_p}$ for $i \leq p$. Consider that a type p unit, the tagged unit, arrives at time $t = 0$, and spends a total time t_p in the queue. Its attained priority at the time of its acceptance into the service facility will be $b_p t_p$, as shown in Fig. C.3.

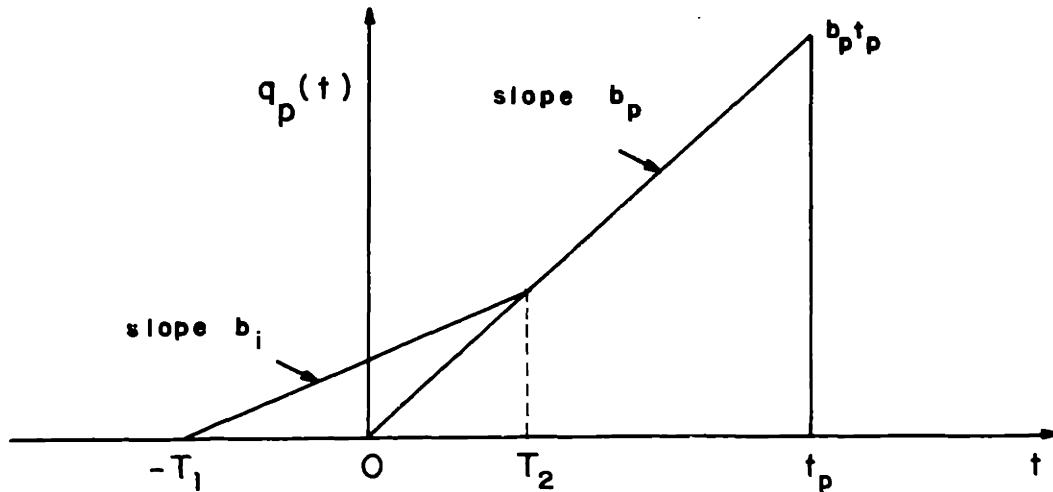

Figure C.3 Diagram of priority, $q_p(t)$, for obtaining f_{ip} .

Upon its arrival, the tagged unit finds n_i type i units already in the queue. Let us consider one such type i unit, as shown in the figure, which arrived at $t = -T_1$. In looking for f_{ip} , we must calculate how many type i units arrive before $t = 0$, and obtain service before the tagged unit does. It is obvious from the figure that a type i unit which arrives at time $-T_1$ ($T_1 > 0$) and which waits in the queue a time $w_i(T_1)$ such

that $T_1 \leq w_i(T_1) \leq T_1 + T_2$ will satisfy these conditions. Obviously, the reason that $w_i(T_1)$ must not exceed $T_1 + T_2$ is that for $w_i(T_1) > T_1 + T_2$ the i type unit will be of lower priority than the tagged unit, and will therefore fail to meet the conditions stipulated above. Note that T_2 may exceed t_p , but this does not violate our conditions since in that case the i type unit must surely be serviced before the tagged unit is serviced.

Therefore, let us first solve for T_2 . Clearly,

$$b_p T_2 = b_i (T_1 + T_2)$$

and so

$$T_2 = \frac{b_i}{b_p - b_i} T_1$$

or

$$T_1 + T_2 = \frac{b_p}{b_p - b_i} T_1$$

It is clear that the expected number, $E(n_i)_{ip}$, of i type units which are in the queue at $t = 0$ and which also obtain service before the tagged unit does, can be expressed as

$$E(n_i)_{ip} = \int_0^{\infty} \lambda_i P_r \left[t \leq w_i(t) \leq \frac{b_p}{b_p - b_i} t \right] dt \quad (C.21)$$

where $\lambda_i dt$ is the expected number of i type units that arrived during the time interval

$(-t-dt, -t)$ and where $P_r \left[t \leq w_i(t) \leq \frac{b_p}{b_p - b_i} t \right]$ is the probability that a unit which arrived in that interval spends at least t and at most $\frac{b_p}{b_p - b_i} t$ seconds in the queue.

Equation C.21 can be written as

$$\begin{aligned} E(n_i)f_{ip} &= \lambda_i \int_0^{\infty} [1 - P_r(w_i \leq t)] dt - \lambda_i \int_0^{\infty} \left[1 - P_r\left(w_i \leq \frac{b_p}{b_p - b_i} t\right) \right] dt \\ &= \lambda_i \int_0^{\infty} [1 - P_r(w_i \leq t)] dt - \lambda_i \left(1 - \frac{b_i}{b_p}\right) \int_0^{\infty} [1 - P_r(w_i \leq \sigma)] d\sigma \end{aligned}$$

where we have set

$$\sigma = \frac{b_p}{b_p - b_i} t$$

Now, as is well-known* (for w_i a nonnegative random variable),

$$E(w_i) = \int_0^{\infty} [1 - P_r(w_i \leq x)] dx$$

and since, in our notation $W_i = E(w_i)$, we obtain

$$E(n_i)f_{ip} = \lambda_i W_i - \lambda_i \left(1 - \frac{b_i}{b_p}\right) W_i$$

or

$$f_{ip} = \frac{\lambda_i W_i}{E(n_i)} \frac{b_i}{b_p}$$

But we know that

$$E(n_i) = \lambda_i W_i$$

and therefore,

$$f_{ip} = \frac{b_i}{b_p} \quad \text{for all } i \leq p$$

* See, for example, Morse [19, p. 9]

Having derived expressions for f_{ip} and g_{ip} , we may now substitute for these quantities in Eq. C.20, and obtain,

$$W_p = \frac{W_0 + \sum_{i=p}^P \rho_i W_i + \sum_{i=1}^{p-1} \rho_i W_i \frac{b_i}{b_p}}{1 - \sum_{i=p+1}^P \rho_i \left(1 - \frac{b_p}{b_i}\right)}$$

If we now make use of Theorem 5.4 we can rewrite the above equation as

$$W_p = \frac{\frac{W_0}{1-\rho} - \sum_{i=1}^{p-1} \rho_i W_i \left(1 - \frac{b_i}{b_p}\right)}{1 - \sum_{i=p+1}^P \rho_i \left(1 - \frac{b_p}{b_i}\right)}$$

which establishes Eq. 5.12 of Theorem 5.2.

Let us now show that Eq. 5.13 is indeed the solution to the set of recursively defined W_p , as expressed in Eq. 5.12. We proceed to show this by an inductive proof on p .

First, for $p = 1$, we get, from Eq. 5.13

$$W_1 = \frac{W_0}{1-\rho} \frac{1}{D_1} = \frac{W_0}{1-\rho} \left[\frac{1}{1 - \sum_{i=2}^P \rho_i \left(1 - \frac{b_1}{b_i}\right)} \right]$$

which checks with the value of W_1 obtained from Eq. 5.12.

For $p = 2$, we get, from Eq. 5.13

$$W_2 = \frac{W_0}{1-\rho} \frac{1}{D_2} [1 + F_1(2)]$$

$$= \frac{W_0}{1-\rho} \frac{1 - \frac{\rho_1 \left(1 - \frac{b_1}{b_2}\right)}{P}}{1 - \frac{\sum_{i=2}^P \rho_i \left(1 - \frac{b_1}{b_i}\right)}{P}} \frac{1 - \frac{\rho_1 \left(1 - \frac{b_1}{b_2}\right)}{P}}{1 - \frac{\sum_{i=3}^P \rho_i \left(1 - \frac{b_2}{b_i}\right)}{P}}$$

which checks with the value of W_2 obtained from Eq. 5.12.

Now, as is usual in an inductive proof, we assume that the solution holds for all $p \leq k$, and we show that this implies that the solution is correct for $p = k + 1$. Let us therefore write down the expression W_{k+1} from Eq. 5.12, using the fact that W_k, W_{k-1}, \dots, W_1 may be evaluated from Eq. 5.13.

$$W_{k+1} = \frac{W_0}{1-\rho} \left(\frac{1}{D_{k+1}} \right) \left\{ 1 - \sum_{i=1}^k \rho_i \left(1 - \frac{b_i}{b_{k+1}} \right) \frac{1}{D_i} \left[1 + \sum_{j=1}^{i-1} \sum_{0 < i_1 < \dots < i_j < i} F_{i_1}(i_2) \dots F_{i_j}(i) \right] \right\}$$

$$= \frac{W_0}{1-\rho} \left(\frac{1}{D_{k+1}} \right) \left\{ 1 + \sum_{i=1}^k F_i(k+1) \left[1 + \sum_{j=1}^{i-1} \sum_{0 < i_1 < \dots < i_j < i} F_{i_1}(i_2) \dots F_{i_j}(i) \right] \right\}$$

where we have taken the liberty of using the notation of Eqs. 5.14 and 5.15. Now, comparing this last equation with the expression obtained for W_{k+1} from Eq. 5.13, we

see that the induction proves the result if the following identity exists:

$$\sum_{i=1}^k F_i^{(k+1)} \left[1 + \sum_{j=1}^{i-1} \sum_{0 < i_1 < \dots < i_j < i} F_{i_1}(i_2) \dots F_{i_j}(i) \right] = \sum_{j=1}^k \sum_{0 < i_1 < \dots < i_j < k+1} F_{i_1}(i_2) \dots F_{i_j}(k+1)$$

It is clear that both sides of this equation involve n -tuples of the F factors. Therefore, in order to prove the validity of this expression, let us show that the same sets of n -tuples appear on both sides of the equation. First, for $n=1$, we require that

$$\sum_{i=1}^k F_i^{(k+1)} = \sum_{i_1=1}^k F_{i_1}^{(k+1)}$$

which is obviously correct. Now for $n > 1$, we require that the n -tuples agree, and so, writing only the n -tuples for each side of the equation, we have

$$\sum_{i=1}^k F_i^{(k+1)} \sum_{0 < i_1 < \dots < i_{n-1} < i} F_{i_1}(i_2) \dots F_{i_{n-1}}(i) = \sum_{0 < i_1 < \dots < i_n < k+1} F_{i_1}(i_2) \dots F_{i_n}(k+1)$$

If, on the right hand side of this last equation, we separate out the summation involving i_n , as follows,

$$\sum_{0 < i_1 < \dots < i_n < k+1} F_{i_1}(i_2) \dots F_{i_n}(k+1) = \sum_{i_n=1}^k F_{i_n}^{(k+1)} \sum_{0 < i_1 < \dots < i_{n-1} < i_n} F_{i_1}(i_2) \dots F_{i_{n-1}}(i_n)$$

we find that the n -tuples do indeed agree (i. e., let $i_n = i$ in this last expression). Thus we have proven the validity of Eq. 5.13 and this completes the proof of Theorem 5.2 .

C.5 Theorem 5.3 and its proof

THEOREM 5.3

For the delay dependent priority system with pre-emption and
for $0 \leq \rho < 1$,

$$W_p = \frac{\frac{W_0}{1-\rho} + \sum_{i=p+1}^P \frac{\rho_i}{\mu_p} \left(1 - \frac{b_p}{b_i}\right) - \sum_{i=1}^{p-1} \frac{\rho_i}{\mu_i} \left(1 - \frac{b_i}{b_p}\right) - \sum_{i=1}^{p-1} \rho_i W_i \left(1 - \frac{b_i}{b_p}\right)}{1 - \sum_{i=p+1}^P \rho_i \left(1 - \frac{b_p}{b_i}\right)}$$

PROOF:

Here, we use notation very similar to that used in the proof of Theorem 5.2 except that all quantities will refer to time spent in the queue plus service facility, instead of just in the queue as was the case in Theorem 5.2.

Following through with almost identical arguments, we arrive at the following expressions:

$$E(n_i) = \lambda_i T_i$$

$$E(m_i) = \lambda_i T_p$$

$$f_{ip} = \begin{cases} \frac{b_i}{b_p} & i \leq p \\ 1 & i \geq p \end{cases}$$

$$g_{ip} = \begin{cases} 0 & i \leq p \\ 1 - \frac{b_p}{b_i} & i \geq p \end{cases}$$

where n_i is now defined as the total number of type i units which were present in the system (queue plus service facility) when the tagged unit arrived, and m_i is defined as the total number of type i units which enter the system while the tagged unit is in the system.

The expression for T_p is therefore

$$T_p = \frac{1}{\mu_p} + \sum_{i=1}^P \frac{\lambda_i T_i}{\mu_i} f_{ip} + \sum_{i=1}^P \frac{\lambda_i T_p}{\mu_i} g_{ip}$$

This equation is obtained from reasoning quite similar to that used in forming Eq. C.19.

Now, using the expressions for f_{ip} and g_{ip} , and also remembering that

$W_i + 1/\mu_i = T_i$ we obtain,

$$\begin{aligned} W_p = T_p - \frac{1}{\mu_p} &= \sum_{i=1}^P \rho_i \left(W_i + \frac{1}{\mu_i} \right) \frac{b_i}{b_p} + \frac{W_0}{1-\rho} - \sum_{i=1}^P \rho_i \left(W_i + \frac{1}{\mu_i} \right) \\ &+ \sum_{i=p+1}^P \rho_i \left(W_p + \frac{1}{\mu_p} \right) \left(1 - \frac{b_p}{b_i} \right) \end{aligned}$$

where we have also made an application of Theorem 5.4 in this last expression.

Solving for W_p , and collecting terms, we obtain finally,

$$W_p = \frac{\frac{W_0}{1-\rho} + \sum_{i=p+1}^P \frac{\rho_i}{\mu_p} \left(1 - \frac{b_p}{b_i} \right) - \sum_{i=1}^{p-1} \frac{\rho_i}{\mu_i} \left(1 - \frac{b_i}{b_p} \right) - \sum_{i=1}^{p-1} \rho_i W_i \left(1 - \frac{b_i}{b_p} \right)}{1 - \sum_{i=p+1}^P \rho_i \left(1 - \frac{b_p}{b_i} \right)}$$

which is the same as Eq. 5.16 and so proves Theorem 5.3.

Note that, $E(n)$, the expected number of units in the system, is

$$E(n) = \sum_{p=1}^P E(n_p) = \sum_{p=1}^P \lambda_p T_p$$

C.6 Theorem 5.5 and its proof

THEOREM 5.5

The expected value of the total time, T_n , spent in the late arrival system for a message whose service time is nQ seconds, is

$$T_n = \frac{nQ}{1-\rho} - \frac{\lambda Q^2}{1-\rho} \left[1 + \frac{(1-\sigma)\alpha(1-\alpha^{n-1})}{(1-\sigma)^2(1-\rho)} \right]$$

where

$$\alpha = \sigma + \lambda Q$$

PROOF:

Let us first prove Eq. 5.24, which is the expected value of the distribution

r_k , where

$$r_k = (1-a)a^k$$

clearly,

$$E = \sum_{k=0}^{\infty} k r_k$$

$$E = \frac{a}{1-a}$$

But

$$a = \frac{\rho\sigma}{1-\lambda Q}$$

and so

$$E = \frac{\rho \sigma}{1 - \rho}$$

where we have used the definition of $\rho = \frac{\lambda Q}{1 - \sigma}$ as before. This establishes Eq. 5.24 .

Now, for the theorem. The following arguments are based exclusively on expected values. Consider the arrival of a unit (the tagged unit) whose service time is nQ seconds. Let D_i be the expected value of the delay (or time spent) between the completion of its $(i-1)^{\text{st}}$ service interval, and the completion of its i^{th} service interval. We complete this definition by assuming that the completion of its i^{th} service interval occurs at its time of arrival. Clearly then, T_n , the expected value of the total time spent in the system for such a unit, will be

$$T_n = \sum_{i=1}^n D_i$$

Let us further define N_i as the expected number of service intervals (or units) which are taken care of between the completion of the $(i-1)^{\text{st}}$ and i^{th} service interval of the tagged unit, i.e.,

$$N_i = \frac{D_i}{Q}$$

and so

$$T_n = Q \sum_{i=1}^n N_i \quad (\text{C.22})$$

We now derive a general form for N_i . Upon its arrival to the system, the tagged unit finds a certain number of units in the queue, the expected value of which is E by definition. Note that the service facility is empty whenever a new unit

enters the system. Thus

$$N_1 = E + 1$$

The addition of unity is due to the service interval used up in serving the tagged unit's first time interval. Now, each of these E units will remain in the system with probability σ , and so $\sigma(N_1 - 1)$ of them will contribute to N_2 . In addition, during the time, $Q(N_1 - 1)$, devoted to servicing these E units, we expect λ new units to arrive per second, and so we must also add $\lambda Q(N_1 - 1)$ more units to N_2 . Besides all this, for $n > 1$, we must add one more (the tagged unit itself) to N_2 , giving

$$\begin{aligned} N_2 &= \sigma(N_1 - 1) + \lambda Q(N_1 - 1) + 1 \\ &= (\sigma + \lambda Q) E + 1 \end{aligned}$$

In calculating N_3 , we see that a fraction σ of the units which were served before the second time interval of the tagged unit will remain in the system, i.e., $\sigma(N_2 - 1)$. In addition during the time $Q(N_2 - 1)$ devoted to servicing these units, $\lambda Q(N_2 - 1)$ new units will arrive. Also, for $n > 2$, we must add one more (the tagged unit again) to N_3 . However, we now notice a new effect entering, namely, the presence of a unit which arrived (with probability λQ) at the conclusion of the first service interval of the tagged unit. This additional unit was placed in back of the tagged unit when it arrived, and therefore did not appear in N_2 . However, from now on, it will appear as an additional λQ added to each N_i for $i \geq 3$. Thus

$$\begin{aligned} N_3 &= \sigma(N_2 - 1) + \lambda Q(N_2 - 1) + 1 + \lambda Q \\ &= (\sigma + \lambda Q)^2 E + \lambda Q + 1 \end{aligned}$$

For N_i , we merely repeat the arguments used in finding N_3 , with the substitution N_i for N_3 and N_{i-1} for N_2 . This gives us, for $i=3, 4, \dots, n$,

$$\begin{aligned} N_i &= \sigma(N_{i-1} - 1) + \lambda Q(N_{i-1} - 1) + \lambda Q + 1 \\ &= (\sigma + \lambda Q)(N_{i-1} - 1) + \lambda Q + 1 \end{aligned} \quad (\text{C.23})$$

Now, letting $\alpha = \sigma + \lambda Q$, we assert that

$$N_i = \alpha^{i-1} E + \lambda Q \sum_{j=0}^{i-3} \alpha^j + 1 \quad (\text{C.24})$$

is the solution of Eq. C.23 for $i=3, 4, \dots, n$. Let us prove this by induction. Clearly, it holds for $i=3$. Assuming its validity for N_{i-1} , we will show its validity for N_i as follows:

$$\begin{aligned} N_i &= \alpha(N_{i-1} - 1) + \lambda Q + 1 \\ &= \alpha \left[\alpha^{i-2} E + \lambda Q \sum_{j=0}^{i-4} \alpha^j \right] + \lambda Q + 1 \\ &= \alpha^{i-1} E + \lambda Q \sum_{j=0}^{i-4} \alpha^{j+1} + \lambda Q + 1 \\ &= \alpha^{i-1} E + \lambda Q \sum_{j=0}^{i-3} \alpha^j + 1 \end{aligned}$$

which proves the assertion. Now if we take the usual definition of

$$\sum_{i=a}^b x_i = 0 \quad \text{for } b < a$$

we see that Eq. C.24 also holds for $i=1, 2$. Thus, we find that $N_i (i=1, 2, \dots, n)$ as

given by Eq. C.24 is the general form we were looking for. Recognizing that, for $0 \leq b$ and $|x| < 1$,

$$\sum_{k=a}^{b+a} x^k = x^a \frac{1-x^{b+1}}{1-x} \quad (\text{C.25})$$

we can readily evaluate N_i . First let us display that $x < 1$ (i.e., that $\alpha < 1$). This is easily done by recalling that we are dealing with systems in equilibrium (steady state). This implies that $\rho < 1$. Substituting for ρ , we get

$$\rho = \frac{\lambda Q}{1-\sigma} < 1$$

or

$$\lambda Q + \sigma < 1$$

This shows, of course, that $\alpha < 1$.

We now use Eq. C.25 in Eq. C.24 and obtain,

$$N_i = \begin{cases} E + 1 & i = 1 \\ \alpha^{i-1} E + \lambda Q \frac{1-\alpha^{i-2}}{1-\alpha} + 1 & i = 2, 3, \dots, n \end{cases} \quad (\text{C.26})$$

Substituting for E , and collecting terms,

$$N_i = \begin{cases} \frac{1-\lambda Q}{1-\rho} & i = 1 \\ \frac{1}{1-\rho} - \frac{\rho(1-\sigma\alpha)}{1-\rho} \alpha^{i-2} & i = 2, 3, \dots, n \end{cases} \quad (\text{C.27})$$

We are now in a position to evaluate T_n , from Eq. C.22 by substituting in

Eq. C. 27. Performing the required operations, and recognizing that $1-\alpha = (1-\sigma)(1-\rho)$ leads us to

$$T_n = \frac{nQ}{1-\rho} - \frac{\lambda Q^2}{1-\rho} \left[1 + \frac{(1-\sigma)\alpha(1-\alpha)^{n-1}}{(1-\sigma)^2(1-\rho)} \right]$$

which completes the proof of Theorem 5.5.

C.7 Theorem 5.6 and its proof

THEOREM 5.6

The expected value of T_n , of the total time spent in the early arrival system for a message whose service is nQ seconds, is

$$T_n = \frac{nQ}{1-\rho} - \rho Q - \frac{\lambda Q^2 \rho}{1-\rho} \left[1 + \frac{(1-\sigma)\alpha(1-\alpha)^{n-1}}{(1-\sigma)^2(1-\rho)} \right]$$

PROOF:

Let us first establish the distribution of r_k as given by Eq. 5.27. Using methods similar to those of Morse [19], we derive the following equilibrium relationships among the r_k :

$$\lambda Q r_0 = (1-\sigma)(1-\lambda Q)r_1$$

$$[(1-\sigma)(1-\lambda Q) + \lambda Q \sigma] r_1 = \lambda Q r_0 + (1-\sigma)(1-\lambda Q)r_2$$

$$[(1-\sigma)(1-\lambda Q) + \lambda Q \sigma] r_k = \lambda Q \sigma r_{k-1} + (1-\sigma)(1-\lambda Q) r_{k+1} \quad k \geq 2$$

As before, let

$$a = \frac{\rho \sigma}{1-\lambda Q}$$

$$\rho = \frac{\lambda Q}{1-\sigma}$$

It is then a simple matter to show that the solution to the above equations is

$$r_k = \begin{cases} 1-\rho & k = 0 \\ \frac{1-\rho}{\sigma} a^k & k = 1, 2, \dots \end{cases}$$

which proves Eq. 5.27.

The expected value of the above distribution is

$$\begin{aligned} E &= \sum_{k=0}^{\infty} k r_k \\ &= \frac{1-\rho}{\sigma} a \sum_{k=0}^{\infty} k a^{k-1} \\ &= \frac{(1-\rho)a}{(1-a)^2 \sigma} \end{aligned}$$

But

$$\begin{aligned} 1-a &= 1 - \frac{\rho \sigma}{1-\lambda Q} \\ &= \frac{(1-\lambda Q - \sigma) + \sigma(1-\rho)}{1-\lambda Q} \\ &= \frac{1-\rho}{1-\lambda Q} \end{aligned}$$

Thus

$$E = \frac{\rho}{1-\rho} (1-\lambda Q)$$

which proves Eq. 5.28.

Now, for the theorem. The arguments needed here are quite similar to those used in Theorem 5.5, and will therefore be considerably shortened. In particular, define T_n , D_i and N_i as previously, thereby establishing Eq. C.22 again. Let us

now derive a general form for N_i . Upon entering the system, the tagged unit finds E units in the system. Now, if there is a unit in the service facility (which occurs with probability $1-r_0 = \rho$) only E minus the expected value of the number in the service facility will contribute to N_1 (since any unit in service must be on the verge of being ejected from service). Well, this expected value is just

$$0 \cdot (r_0) + 1 \cdot (1-r_0) = \rho$$

and so

$$N_1 = E - \rho + 1$$

where the $+1$ term is due to the tagged unit itself. Following the same reasoning as in Theorem 5.5, we find that

$$N_2 = \lambda Q(N_1) + \sigma(N_1 - 1) + \sigma\rho$$

where the $\sigma\rho$ term is due to the unit (if there is one) found in service at the time of arrival of the tagged unit. Using the same type of argument, we find for $i > 2$,

$$N_i = \lambda Q(N_{i-1}) + \sigma(N_{i-1} - 1) + 1$$

where, for $i > 2$, we omit the $\sigma\rho$ term since it is fully accounted for in N_2 . We assert that the solution to this set of equations is,

$$N_i = \begin{cases} E + 1 - \rho & i = 1 \\ \alpha^{i-1} E + \alpha^{i-2} \lambda Q(1 - \rho) + \lambda Q \sum_{j=0}^{i-3} \alpha^j + 1 & i > 1 \end{cases} \quad (\text{C. 28})$$

That this is indeed the solution is easily shown by induction on i as follows. Clearly, it is true for $i = 1, 2$. Now, assuming its validity for N_{i-1} , we will show its validity for N_i as follows:

$$\begin{aligned}
 N_i &= \alpha N_{i-1} + 1 - \sigma \\
 &= \alpha \left[\alpha^{i-2} E + \alpha^{i-3} \lambda Q (1 - \rho) + \lambda Q \sum_{j=0}^{i-4} \alpha^j + 1 \right] + 1 - \sigma \\
 &= \alpha^{i-1} E + \alpha^{i-2} \lambda Q (1 - \rho) + \lambda Q \sum_{j=1}^{i-3} \alpha^j + \alpha + 1 - \sigma \\
 &= \alpha^{i-1} E + \alpha^{i-2} \lambda Q (1 - \rho) + \lambda Q \sum_{j=0}^{i-3} \alpha^j + 1
 \end{aligned}$$

which proves the assertion. Substituting for E , performing the indicated summation, and collecting terms gives us

$$N_i = \begin{cases} \frac{\rho}{1-\rho} (1-\lambda Q) + 1 - \sigma & i = 1 \\ \frac{1}{1-\rho} - \frac{\rho^2 (1-\sigma\alpha)}{1-\rho} \alpha^{i-2} & i = 2, 3, \dots, n \end{cases} \quad (\text{C. 29})$$

We are now in a position to evaluate T_n , from Eq. C. 22 by substituting in Eq. C. 29. Performing the required operations leads us to

$$T_n = \frac{nQ}{1-\rho} - \rho Q - \frac{\lambda Q^2 \rho}{1-\rho} \left[1 + \frac{(1-\sigma\alpha)(1-\alpha^{n-1})}{(1-\sigma)^2 (1-\rho)} \right]$$

which proves Theorem 5.6.

C.8 Theorem 5.7 and its proof

THEOREM 5.7

The expected value, T_n , of the total time spent in the strict first come first served system for a message whose service time is nQ seconds, is

$$T_n = \frac{QE}{1-\sigma} + nQ$$

where

$$E = \frac{\rho\sigma}{1-\rho}$$

PROOF:

Let us first consider the late arrival system. Arguing on an expected value basis, we recognize that, upon entry, the tagged unit finds $E(= \frac{\rho\sigma}{1-\rho})$ units in the system. Each unit in the queue has an expected service time of $\frac{Q}{1-\sigma}$. Now, as far as the unit in service is concerned, we appeal to the discussion leading up to Eq. C.2 for the exponential distribution and assert that the same type of result holds. That is, we assert that the expected additional service time for the unit in service is $\frac{Q}{1-\sigma}$ (given that more service is required). That this assertion is true may be shown by recognizing that the geometric distribution is the discrete counterpart of the exponential distribution. Thus, each of the E units in the system (queue plus service) will delay the tagged unit by $\frac{Q}{1-\sigma}$ seconds, and this unit will spend nQ seconds in service itself. Hence, for the late arrival system,

$$T_n = Q \frac{\rho\sigma}{(1-\sigma)(1-\rho)} + nQ$$

which proves Theorem 5.7 for the late arrival system.

For the early arrival system, we recognize that, upon entry, the tagged unit finds $E = \frac{\rho}{1-\rho} (1-\lambda Q)$ in the system. Now, as before, given that the unit in service requires additional service, the expected value of this additional service is $\frac{Q}{1-\sigma}$ seconds. But now, we cannot be sure (as we were in the late arrival system) that the unit in service will require more service; that is, with probability σ , the unit in service will remain for more service. Also, the expected number in service is merely ρ (that is, the probability of finding one unit in service) and so, the delay suffered by the tagged unit due to the unit in service is $\rho\sigma Q/(1-\sigma)$. Each of the units in the queue (the expected number of which is $E - \rho$) will, on the average, delay the tagged unit by $\frac{Q}{1-\sigma}$ seconds. In addition, the tagged unit will spend nQ seconds in service. Hence, for the early arrival system,

$$\begin{aligned} T_n &= (E - \rho) \frac{Q}{1-\sigma} + \rho\sigma \frac{Q}{1-\sigma} + nQ \\ &= \frac{Q}{1-\sigma} \left[E - \rho(1-\sigma) \right] + nQ \end{aligned}$$

Note that $\Delta = \rho(1-\sigma) = \frac{\rho}{1-\rho} (1-\lambda Q) - \frac{\rho\sigma}{1-\rho}$ and so, we see that

$$T_n = Q \frac{\rho\sigma}{(1-\sigma)(1-\rho)} + nQ$$

which proves Theorem 5.7 for the early arrival system.

For the early arrival finds $E = \frac{\rho}{1-\rho} (1-\lambda Q)$ in t requires additional service seconds. But now, we can unit in service will require will remain for more servi (that is, the probability of the tagged unit due to the u (the expected number of wh $\frac{Q}{1-\sigma}$ seconds. In addition, for the early arrival system

$$T_n = (E - \frac{Q}{1-\sigma})$$

Note that $\Delta = \rho(1-\sigma) = \frac{\rho}{1-\rho}$

$$T_n = Q - \Delta$$

which proves Theorem 5.7

APPENDIX D

THEOREMS AND PROOFS FOR CHAPTER VI

D.1 Definitions and Derived Expressions for \bar{n}

We define

x_n as the node visited by a message on its n^{th} step in the process.

Thus, x_n defines the system state at step n . Further, let node N represent the destination or absorbing node for our message. We define

$$\begin{aligned} r_n &= P_r \text{ [message reaches node } N \text{ on exactly the } n^{\text{th}} \text{ step]} \\ s_n &= P_r \text{ [message reaches node } N \text{ on or before the } n^{\text{th}} \text{ step]} \\ g_n &= P_r \text{ [message reaches node } N \text{ on exactly the } n^{\text{th}} \text{ step} \\ &\quad \text{given that it did not reach node } N \text{ before the } n^{\text{th}} \text{ step.]} \end{aligned}$$

Also, define, for completeness, $s_n = 0$ for $n < 0$. Furthermore, as usual, we define \bar{n} , the expected number of steps to reach state N , as

$$\bar{n} = \sum_{n=0}^{\infty} n r_n \quad . \quad (\text{D.1})$$

We now proceed to derive two other forms for \bar{n} . We consider only finite Markov processes which consist of exactly one closed set (namely state N , itself)*. Since the message must eventually be absorbed in node N , we see that

$$\sum_{n=0}^{\infty} r_n = 1 \quad . \quad (\text{D.2})$$

*See Feller [13, Sect. XV.4].

Thus states $0, 1, 2, \dots, N-1$ are transient states. Furthermore, by definition,

$$s_n = \sum_{m=0}^n r_m \quad . \quad (D.3)$$

Now, Eq. D.1 may be written as

$$\bar{n} = \sum_{n=1}^{\infty} r_n \sum_{m=0}^{n-1} 1 \quad .$$

Inverting the order of summation, we obtain

$$\begin{aligned} \bar{n} &= \sum_{m=0}^{\infty} \sum_{n=m+1}^{\infty} r_n \\ &= \sum_{m=0}^{\infty} \left\{ \sum_{n=0}^{\infty} r_n - \sum_{n=0}^m r_n \right\} . \end{aligned}$$

Using Eq. D.2 and D.3, we get as an alternate form* for \bar{n} ,

$$\bar{n} = \sum_{n=0}^{\infty} (1 - s_n) \quad . \quad (D.4)$$

From its definition, we see that

$$g_n = \frac{r_n}{1 - s_{n-1}}$$

*Feller derives this same expression in a different manner (see [13, P. 249]).

and since, from Eq. D.3

$$r_n = s_n - s_{n-1}$$

we get

$$g_n = \frac{s_n - s_{n-1}}{1 - s_{n-1}}$$

or

$$1 - g_n = \frac{1 - s_n}{1 - s_{n-1}} .$$

It is now clear that

$$\prod_{m=0}^n (1 - g_m) = \prod_{m=0}^n \frac{1 - s_m}{1 - s_{m-1}} = 1 - s_n . \quad (D.5)$$

Thus, from Eqs. D.4 and D.5, we obtain

$$\bar{n} = \sum_{n=0}^{\infty} (1 - g_0) (1 - g_1) \dots (1 - g_n) . \quad (D.6)$$

Thus, we see that knowledge of either the set r_n or the set s_n or the set g_n is sufficient of obtain \bar{n} as given by Eqs. D.1, D.4, or D.6 respectively.

D.2 Theorem 6.1 and its Proof

THEOREM 6.1

The average path length, \bar{n}_i , from node i to node N for any finite

dimensional irreducible Markov process whose probability transition matrix is a circulant matrix (see Eq. 6.2), is

$$\bar{n}_i = \sum_{r=1}^N \frac{1 - \theta^{r(i+1)}}{1 - \sum_{s=0}^N q_s \theta^{sr}}$$

where $i = 0, 1, 2, \dots, N$, and where θ is the $(N+1)^{\text{th}}$ primitive root of unity, i.e.,

$$\theta = e^{2\pi j/(N+1)}$$

and where

$$j = \sqrt{-1}$$

PROOF:

Let*

$$p_{ij}^{(n)} = P_r [x_n = j \mid x_0 = i]$$

and

$$f_{ij}^{(n)} = P_r [x_n = j, x_m \neq j (m=1, 2, \dots, n-1) \mid x_0 = i].$$

* See Sect. 6.1 for the definition of x_n .

That is, $p_{ij}(n)$ is the probability of the event that the message is in node j exactly n steps after being in node i ; $f_{ij}(n)$ is the probability that this event occurs at step n for the first time (i. e., it is the first passage probability). We also define the two generating functions for those probabilities as

$$P_{ij}(t) = \sum_{n=0}^{\infty} p_{ij}(n) t^n \quad -1 < t < 1 \quad (\text{D. 7})$$

$$F_{ij}(t) = \sum_{n=0}^{\infty} f_{ij}(n) t^n \quad -1 < t < 1 \quad (\text{D. 8})$$

Now, it is clear that if the message is in node j after n steps, then it must have reached this node for the first time on the n_1^{th} step ($n_1 \leq n$) and also must have gone from node j back to node j (perhaps many times) in $n - n_1$ steps. This is expressed in the following equation:

$$p_{ij}(n) = \sum_{n_1=0}^n f_{ij}(n_1) p_{jj}(n - n_1) \quad .$$

Now, multiplying by t^n and summing over all n , we get,

$$\sum_{n=0}^{\infty} p_{ij}(n) t^n = \sum_{n=0}^{\infty} \sum_{n_1=0}^n f_{ij}(n_1) p_{jj}(n - n_1) t^{n_1} t^{n - n_1} \quad .$$

Interchanging orders of summation, and setting $n_2 = n - n_1$, we obtain

$$\sum_{n=0}^{\infty} p_{ij}(n) t^n = \sum_{n_1=0}^{\infty} \sum_{n_2=0}^{\infty} f_{ij}(n_1) p_{jj}(n_2) t^{n_1} t^{n_2} \quad . \quad (D.9)$$

We recognize that Eq. D.9 is merely*

$$P_{ij}(t) = F_{ij}(t) P_{jj}(t)$$

or

$$F_{ij}(t) = \frac{P_{ij}(t)}{P_{jj}(t)} \quad . \quad (D.10)$$

We now define the circulant matrix P (finite dimensional and irreducible) as given by Eq. 6.2. For this matrix, Feller [13] has shown that

$$p_{ij}(n) = \frac{1}{N+1} \sum_{r=0}^N \theta^{r(i-j)} \left(\sum_{s=0}^N q_s \theta^{sr} \right)^n \quad (D.11)$$

where θ is the $(N+1)^{\text{th}}$ primitive root of unity as expressed in Eq. 6.4. We now form $P_{ij}(t)$ for this matrix by applying the transformation of Eq. D.7 to Eq. D.11, and obtain

$$P_{ij}(t) = \frac{1}{N+1} \sum_{r=0}^N \theta^{r(i-j)} \left(t \sum_{s=0}^N q_s \theta^{sr} \right)^n \quad (D.12)$$

*See Kemperman [46].

or

$$P_{ij}(t) = \frac{1}{N+1} \sum_{r=0}^N \frac{\theta^{r(i-j)}}{1 - \sum_{s=0}^N q_s \theta^{sr}} \quad (D.13)$$

We are able to sum the geometric series of Eq. D.12 since

$$\left| t \sum_{s=0}^N q_s \theta^{sr} \right| \leq |t| \sum_{s=0}^N q_s = |t| < 1.$$

Thus, substituting Eq. D.13 into Eq. D.10, we obtain

$$F_{ij}(t) = \frac{\sum_{r=0}^N \frac{\theta^{r(i-j)}}{1-tS_r}}{\sum_{r=0}^N \frac{1}{1-tS_r}}$$

or

$$F_{ij}(t) = \frac{1 + (1-t) \sum_{r=1}^N \frac{\theta^{r(i-j)}}{1-tS_r}}{1 + (1-t) \sum_{r=1}^N \frac{1}{1-tS_r}}$$

where

$$S_r = \sum_{s=0}^N q_s \theta^{sr}$$

Upon setting $j = N$, we establish Eq. 6.5.

We now define

\bar{n}_i = Expected number of steps to enter the destination node N for the first time, given that the message originated in node i .

That is,

$$\bar{n}_i = \sum_{n=0}^{\infty} n f_{iN}(n)$$

and since we have a finite irreducible chain, we are assured of the existence of \bar{n}_i .

From Eq. D.8, we see that

$$\frac{\partial F_{iN}(t)}{\partial t} = \sum_{n=0}^{\infty} n f_{iN}(n) t^{n-1}$$

We know that this series converges for $-1 < t < 1$. At $t=1$, the series becomes \bar{n}_i by definition. Since \bar{n}_i exists, we recognize that $\partial F_{iN}(t)/\partial t$ must be continuous in the closed interval $-1 \leq t \leq 1$ (see Feller [13] p. 249 for a similar extension of the region of convergence). Thus, after differentiating Eq. 6.5, setting $t=1$, and noting that $\theta^{i-N} = \theta^{i+1}$, we obtain

$$\bar{n}_i = \sum_{r=1}^N \frac{1-\theta^{r(i+1)}}{1-S_r}$$

which completes the proof of Theorem 6.1.

D.3 Proof of Eqs. 6.6 and 6.7

Making use of Eq. 6.3, we now form

$$\begin{aligned}\bar{n} &= \frac{1}{N} \sum_{i=0}^N \bar{n}_i = \frac{1}{N} \sum_{i=0}^N \sum_{r=1}^N \frac{1-\theta^{r(i+1)}}{1-S_r} \\ &= \frac{1}{N} \sum_{r=1}^N \frac{N+1 - \sum_{i=0}^N \theta^{r(i+1)}}{1-S_r}\end{aligned}$$

But, for $N \geq 1$, we note that

$$\sum_{i=0}^N \theta^{r(i+1)} = \begin{cases} N+1 & \text{for } r=0, N+1 \\ 0 & \text{for } r \neq 0, N+1 \end{cases}$$

and since we have $r=1, 2, \dots, N$, we obtain

$$\bar{n} = \frac{N+1}{N} \sum_{r=1}^N \frac{1}{1-S_r}$$

which proves Eq. 6.6.

Furthermore, we form

$$\bar{n}' = \sum_{i=0}^{N-1} q_{i+1} \bar{n}_i + q_0 \bar{n}_N$$

$$\begin{aligned}
&= \sum_{i=0}^{N-1} q_{i+1} \sum_{r=1}^N \frac{1-\theta^{r(i+1)}}{1-S_r} + q \cdot 0 \\
&= \sum_{r=1}^N \frac{1-q_0 - \sum_{i=0}^{N-1} q_{i+1} \theta^{r(i+1)}}{1-S_r}
\end{aligned}$$

or

$$\bar{n}' = \sum_{r=1}^N \frac{1-S_r}{1-S_r} = N$$

This establishes Eq. 6.7.

D.4 Theorem D.1 and its proof

THEOREM D.1

Given a two channel service facility of total capacity C , Poisson arrivals with mean rate λ , message lengths distributed exponentially with mean length $1/\mu$, and the restriction that no channel be idle if a message is waiting in the queue, then, for an arbitrarily chosen number, $0 \leq \pi_1 \leq 1$ it is not possible to find a queue discipline and an assignment of the two channel capacities (the sum being C) such that

$$P_r \text{ (entering message is transmitted on the first channel)} = \pi_1 \quad (\text{D.14})$$

for all $0 \leq \rho < 1$ where $\rho = \lambda/\mu C$.

PROOF:

We prove this theorem by considering two limiting cases. Suppose $\rho \rightarrow 0$. Then

P_0 (the probability that in the steady state the system is empty) approaches 1. In such a case, an entering message (which will, with probability arbitrarily close to 1, find an empty system) must be assigned to channel 1 with probability π_1 (and to channel 2 with probability $\pi_2 = 1 - \pi_1$) if Eq. D.14 is to hold.

Now suppose $\rho \rightarrow 1$; then P_0 and P_1 (the probability of one message in the system) both approach 0. Therefore, the channel capacity C_1 assigned to channel 1 (which implies $C - C_1 = C_2$ for channel 2) must be chosen so that

$$\alpha = P_r [\text{channel 1 empties before channel 2} \mid \text{both channels busy}] = \pi_1 .$$

That is, with probability arbitrarily close to 1, a message entering the node will be forced to join a queue, and, when it reaches the head of the queue, it will find both channels busy. If this message is to be transmitted over channel 1 with probability π_1 , it must be that the channel capacity assignments result in $\alpha = \pi_1$. Note that we have taken advantage of the fact that messages with exponentially distributed lengths exhibit no memory as regards their transmission time. (See Eq. C.2.)

$$\text{Now, } \alpha = \int_{t=0}^{t=\infty} \frac{P_r [\text{channel 1 empties in } (t, t+dt) \mid \text{both busy at time } 0]}{P_r [\text{channel 2 is not yet empty by } t \mid \text{both busy at time } 0]}$$

$$\alpha = \int_0^{\infty} \mu C_1 e^{-\mu C_1 t} e^{-\mu C_2 t} dt$$

$$\alpha = \mu C_1 / (\mu C_1 + \mu C_2) = C_1 / C$$

but

$$\alpha = \pi_1$$

therefore

$$C_1 = \pi_1 C$$

and also

$$C_2 = \pi_2 C = (1 - \pi_1) C .$$

These two limiting cases for $\rho \rightarrow 0$ and $\rho \rightarrow 1$ have constrained the construction of our system completely.

Now, for any $0 \leq \rho < 1$, let

$$r_1 = P_r \text{ [incoming message is eventually transmitted on channel 1]}$$

$$P_n = P_r \text{ [finding } n \text{ messages in the system in the steady state]}$$

Then clearly,

$$r_1 = \pi_1 P_0 + q_{21} P_1 + \sum_{n=2}^{\infty} \pi_1 P_n \quad (\text{D. 15})$$

where

$$q_{i1} = P_r \text{ [channel } i \text{ is busy | only one channel is busy]}$$

For q_{21} , we write the forward Chapman-Kolmogorov equations (see Sect. A.1)

$$\begin{aligned} q_{21}(t+dt) = & [P_0(t)/P_1(t)] (\lambda \pi_2 dt) + [P_2(t)/P_1(t)] (\mu C_1 dt) \\ & + q_{21}(t) [1 - \lambda dt - \mu C_2 dt] \end{aligned}$$

Assuming a steady state distribution, we get,

$$0 = (P_0/P_1) \lambda \pi_2 + (P_2/P_1) \mu C_1 - (\lambda + \mu C_2) q_{21} \quad (\text{D. 16})$$

Now, since this system satisfies the hypothesis of the Birth-Death Process considered earlier, we apply Eq. A.1, with $d_1 = \mu \bar{E}_1$, $d_n = \mu C$ ($n \geq 2$), $b_n = \lambda$, and obtain

$$P_n = \begin{cases} (C/\bar{E}_1) \rho^n P_0 & n \geq 1 \\ P_0 & n = 0 \end{cases} \quad (\text{D. 17})$$

where

$$\rho = \lambda/\mu C,$$

and*

$$\begin{aligned}\bar{E}_1 &= E[\text{capacity in use} \mid \text{one channel is busy}] \\ &= C_1 q_{11} + C_2 q_{21}\end{aligned}$$

Also, recall that $C_1 = \pi_1 C$ and $C_2 = \pi_2 C = (1 - \pi_1)C$. Thus, Eq. D.16 becomes

$$q_{21} = (\mu \bar{E}_1 \pi_2 + \lambda \pi_1) / (\lambda + \mu C \pi_2) \quad (\text{D.18})$$

similarly

$$q_{11} = (\mu \bar{E}_1 \pi_1 + \lambda \pi_2) / (\lambda + \mu C \pi_1)$$

Now, forming the equation,

$$q_{11} + q_{21} = 1$$

we obtain, after some algebra,

$$\begin{aligned}\mu \bar{E}_1 &= \mu C (\mu C + 2\lambda) / (2\mu C + \lambda / \pi_1 \pi_2) \\ &= \mu C (1 + 2\rho) / (2 + \rho / \pi_1 \pi_2)\end{aligned}$$

We may now write Eq. D.18 as

$$q_{21} = \frac{[\mu C (1 + 2\rho) / (2 + \rho / \pi_1 \pi_2)] \pi_2 + \lambda \pi_1}{\lambda + \mu C \pi_2}$$

Simplifying, we get

$$q_{21} = \pi_1 (\pi_2 + \rho) / (2\pi_1 \pi_2 + \rho) \quad (\text{D.19})$$

Returning to Eq. D.15, we observe that the only way in which r_1 can equal π_1 is for

* See Theorem 4.1.

$q_{21} = \pi_1$. Equation D.19 shows that this is not the case, which demonstrates that Eq. D.14 cannot hold for an arbitrary π_1 , proving the theorem.

However, it can be seen from Eq. D.19, that $q_{21} = \pi_1$ for $\pi_1 = 0, 1/2, 1$ only. Let us now form r_1 from Eqs. D.15 and D.17:

$$r_1 = P_0 \left[\pi_1 + (\lambda q_{21} / \mu \bar{E}_1) + (\pi_1 C / \bar{E}_1) \sum_{n=2}^{\infty} \rho^n \right]$$

where P_0 is found from Eq. D.17 by requiring

$$\sum_{n=0}^{\infty} P_n = 1$$

After substituting and simplifying, we get

$$r_1 = \pi_1 \left[\frac{\pi_1 \rho^2 + (1 - \pi_1^2) \rho + \pi_1 \pi_2}{(1 - 2\pi_1 \pi_2) \rho^2 + 3\pi_1 \pi_2 \rho + \pi_1 \pi_2} \right]$$

Figure D.1 shows a plot of r_1 as a function of ρ , with π_1 as a parameter.

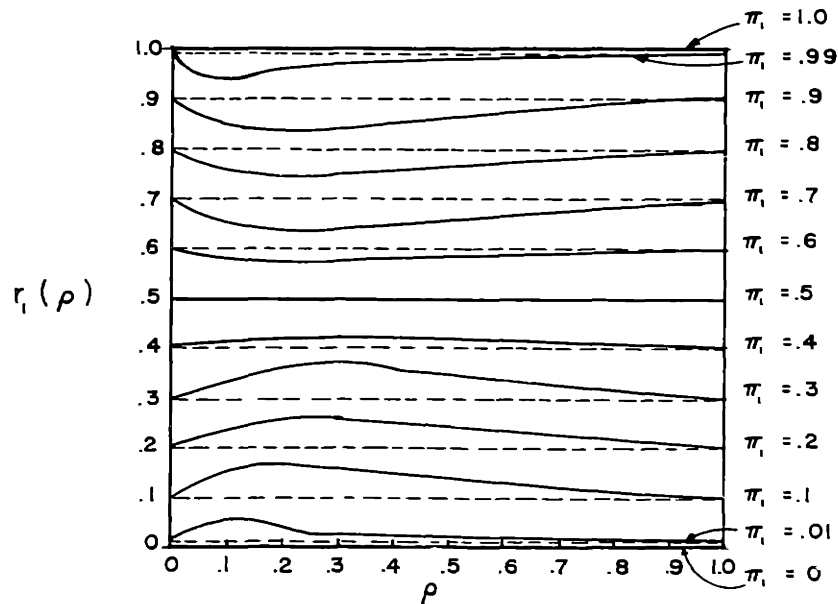

Figure D.1 Variation of r_1 with ρ .

Note that the variation of r_1 is not too great. This illustrates that although Theorem D.1 is stated as a negative result, its proof demonstrates a positive result, namely, that the variation of r_1 is not excessive. The arrangement which gives this behavior is one in which the channel capacity is divided between the two channels in proportion to the desired probabilities (i.e., $C_1 = \pi_i C$) of using each channel, and the discipline followed when a message finds both channels empty, is to choose channel i with probability π_i .

COROLLARY

For the same conditions as Theorem D.1, except allowing N channels, and for $\pi_1 = \pi_2 = \dots = \pi_K = 1/K$, then it is possible to find a queueing discipline and a channel capacity assignment such that

$$P_r(\text{entering message is transmitted over the } i^{\text{th}} \text{ channel}) = 1/K \text{ for all } 0 \leq \rho < 1.$$

PROOF:

In proving Theorem D.1, it was shown that for $\pi_1 = 1/2$, a suitable system could be found to realize this π_1 . This result also follows directly from the complete symmetry of the two channels. Similarly, the proof of this corollary follows trivially from recognizing, once again, the complete symmetry of each of the K channels.

D.5 Theorem 6.2 and its proof

THEOREM 6.2

For the K -connected net,

$$P_n = \begin{cases} P_0 (\bar{n}\rho)^n \frac{K^n}{n!} & n = 0, 1, 2, \dots, K \\ P_0 (\bar{n}\rho)^n \frac{K^K}{K!} & n \geq K \end{cases} \quad (6.8)$$

provided $\bar{n}\rho < 1$, where

$$\rho = \gamma/\mu C \quad (6.9)$$

$$P_0 = \left[\sum_{n=0}^{K-1} \frac{(K\bar{n}\rho)^n}{n!} + \frac{(K\bar{n}\rho)^K}{(1-\bar{n}\rho)K!} \right]^{-1} \quad (6.10)$$

$$\bar{n} = \frac{N+1}{N} \sum_{r=1}^N \frac{1}{1 - (1/K) \sum_{s \in S} \theta^{sr}} \quad (6.11)$$

$$\theta = e^{2\pi j/(N+1)} = (N+1)^{\text{th}} \text{ primitive root of unity.} \quad (6.12)$$

S = the set of integers which corresponds to the position of the elements of the first row of P which are non-zero.

PROOF:

We first show that the nodes in the K -connected net obey the conditions of the birth-death process examined earlier. We do this by showing that the birth and death coefficients are independent of time. Specifically, let

Q_1 = event that a message on the channel connecting node j to node k completes its transmission to node k in an arbitrary time interval $(t, t+dt)$.

Q_2 = event that the channel connecting node j to node k is being used.

Now, clearly, $P_r[Q_1, Q_2]$ is a component of the death coefficient for node j , and is also a component of the birth coefficient for node k ; however, due to the symmetry of the traffic matrix and of the network topology, we see that these birth and death coefficients are representative of those throughout the net. Now,

$$P_r[Q_1, Q_2] = P_r[Q_1 | Q_2] P_r[Q_2]$$

and due to the independent exponential message lengths, we see that*,

$$P_r[Q_1 | Q_2] = \frac{\mu C}{K(N+1)} dt$$

Also, if we define

$$P_n = P_r[n \text{ messages in node } j(\text{say})]$$

then

$$P_r[Q_2] = 1 - P_0 - P_1 \frac{K-1}{K} - P_2 \frac{K-2}{K} - \dots - P_{K-1} \frac{1}{K} \quad (\text{D. 20})$$

Equation D. 20 is of the form $1 - P_r[\text{channel connecting node } j \text{ to node } k \text{ is idle}]$. The subscripts j and k disappear due to the symmetry of all channels. Also, we have invoked the corollary of Theorem D. 1 in obtaining the coefficient for P_n in Eq. D. 20.

Rewriting Eq. D. 20, we obtain

$$P_r[Q_2] = 1 - \sum_{n=0}^{K-1} P_n \frac{K-n}{K} \quad (\text{D. 21})$$

Now, we recognize from Theorem 4. 1, that

$$\rho_j = 1 - \sum_{n=0}^{\infty} \frac{\bar{C}_n}{C_j} P_n$$

where C_j is the sum of the capacity of all channels leaving node j ; due to symmetry, $C_j = C/(N+1)$. But in our case,

* Note that we make use of the Independence Assumption here.

$$\bar{C}_n = \begin{cases} \frac{K-n}{K} C & n \leq K \\ 0 & n \geq K \end{cases}$$

Thus Eq. D. 21 becomes

$$P_r[Q_2] = \rho_j = \frac{\Gamma_j}{\mu C_j}$$

where Γ_j is the total arrival rate of messages to node j (both from internal channels as well as from external sources). Due to symmetry again, $\Gamma_j = \Gamma$. Thus

$$P_r[Q_1, Q_2] = \frac{\mu C}{K(N+1)} dt \frac{\Gamma}{\mu C/(N+1)} = \frac{\Gamma}{K} dt \quad (D. 22)$$

Equation D. 22 states that the inter-departure times of messages are Poisson in nature*, at a mean rate of Γ/K ; this also implies that the birth and death coefficients for all nodes in the net are independent of time.

We now proceed to evaluate the parameter Γ , which represents the average arrival rate of messages to each node (from both external and internal sources). Each time that a new message enters the net from an external source, it brings with it a number of steps that it will take before being received at its destination. We may think of this number as being added to the total number, x , of steps that must be made before all messages currently in the net will be received at their destinations.

Similarly, each time that a message passes from one node to another, the number x is reduced by one. Now, it is clear that if the net is in equilibrium, then the time derivative of the average value \bar{x} , of x , (i.e., $d\bar{x}/dt$) must be zero. Well, the average rate at which steps are created is equal to the product of the average arrival rate of

* This result can be shown to hold for more general nets as well.

messages to the system, γ , and the average number of steps, \bar{n} , that each message will take. Steps are destroyed at a rate equal to the average number of messages completing transmission per unit time, i. e., $\Gamma(N+1)$. Thus

$$\gamma \bar{n} = \Gamma(N+1)$$

or

$$\Gamma = \frac{\gamma \bar{n}}{N+1}$$

Furthermore, due to the simple form of the traffic matrix, the circulant form of the network topology and of the random routing procedure, we recognize that the conditions for Theorem 6.1 are satisfied; accordingly, \bar{n} is calculated from Eq. 6.6. Thus, the time independent birth and death coefficients for a node are, respectively,

$$b_n = \Gamma = \gamma \bar{n} / (N+1)$$

$$d_n = \begin{cases} n\mu C / K(N+1) & n \leq K \\ \mu C / (N+1) & n \geq K \end{cases}$$

We apply these coefficients to Eq. A.1 and obtain

$$P_n = \begin{cases} P_0 (\bar{n}\rho)^n K^n / n! & n \leq K \\ P_0 (\bar{n}\rho)^n K^K / K! & n \geq K \end{cases}$$

provided $\bar{n}\rho < 1$, and where ρ , P_0 and \bar{n} are obviously equal to the expressions in Eqs. 6.9 - 6.11. This completes the proof of Theorem 6.2.

D.6 Theorem 6.3 and its proof

THEOREM 6.3

For the K-connected net,

$$T = \frac{(N+1)K\bar{n}}{\mu C} + \frac{\bar{n}(N+1)}{\mu C(1-\bar{n}\rho)} \left[\frac{1}{(1-\bar{n}\rho)S_K + 1} \right] \quad (6.13)$$

where

$$S_K = \sum_{n=0}^{K-1} (K\bar{n}\rho)^{n-K} \frac{K!}{n!} \quad (6.14)$$

and ρ and \bar{n} are as defined in Theorem 6.2.

PROOF:

We observe that Eq. 6.8 is of the same form as Eq. A.9 with $N=K$, C replaced by $C/(N+1)$, and ρ replaced with $\bar{n}\rho$. Thus, the expected time, T_0 , that a message spends in each node of the net is, by Eq. A.14,

$$T_0 = \frac{K(N+1)}{\mu C} + \frac{P(\geq K)}{(1-\bar{n}\rho)\mu C/(N+1)}$$

Substituting for $P(\geq K)$, and rearranging terms, we get

$$T_0 = \frac{K(N+1)}{\mu C} + \frac{N+1}{\mu C(1-\bar{n}\rho)} \left[\frac{1}{(1-\bar{n}\rho)S_K + 1} \right]$$

where S_K is as given in Eq. 6.14. We now recognize that for the K-connected net (as defined in Sect. 6.4) Eq. 6.1 must hold exactly (i. e., the expected delay, T_0 , is the same for all nodes), and so $T = \bar{n}T_0$ which proves Theorem 6.3.

APPENDIX E

AN OPERATIONAL DESCRIPTION OF THE SIMULATION PROGRAM

The simulation program is designed to simulate the operation of a wide variety of communication nets such as described in Chapter 1. The program was written by the author for the TX-2 [39] (a large scale high speed digital computer at Lincoln Laboratory). *

The program requires the following specification of the net it is to simulate:

- (1) The number of nodes, N .
- (2) A topological description - specifically, the capacity of all N^2 channels (many of which may be of zero capacity).
- (3) γ , the total average number of messages per second entering the net
- (4) $1/\mu$, the average message length **
- (5) The traffic matrix (whose ij entry represents the relative traffic with origin at node i , and destination at node j)
- (6) The number of priority classes and the relative arrival rate of messages from each class
- (7) A set of lists which describe the routing procedure to be used (see Section 7.1).
- (8) A stopping parameter, namely, the total number of messages to be transmitted through the net.

The maximum number of nodes, N , that can be accommodated is 36 (this can be

* The program consists of approximately 1800 machine instructions.

** All message lengths are chosen from the same exponential distribution.

extended with some minor program changes). The program, at present, generates inter-arrival times and message lengths which are exponentially distributed with mean $1/\gamma$ and $1/\mu$ respectively. These distributions are obtained either from a built in radioactive random number generator, or from a psuedo-random number generator in the program. The restriction to exponential distributions can be removed and made to include more general distributions with some simple program changes.

The program operates as a differential event simulator. By this we mean that the program does not run on synchronous time, but rather time is immediately updated to the occurrence time of the next random event. Extensive use is made of the tied list concept wherein each memory location gives the address of the next memory location in the list. While running, the program generates messages (which are defined by their origin, destination, arrival time to the network, length, and priority) according to the items specified in the list above, routes these messages through the net (placing them on queues when necessary and obeying the imposed queue discipline), and finally delivers them to their destination. During this process, the program gathers the statistics called for (see below). Furthermore, the simulation is under control of the console operator at all times. For example, he may stop the program at any time, observe the accumulated data and then continue. Also, he may observe the dynamic operation of the net while it is running. For this last purpose, he uses the console oscilloscope which displays information for visual or photographic consumption.

Figure E. 1 illustrates a typical display as might be observed during the simulation. The number in the upper left hand corner (4453) is the total number of messages generated so far. The three horizontal lines below that, measure certain aspects of the number of messages in the system: ^{*} the lowest of these displays represents $n(t)$, the current

* The number immediately above these three lines serves to calibrate the vertical reticle (shown dotted) which is superimposed over the three lines. In this case, the full range of the scale is 100 messages.

number of messages in the system (in queues and in transmission channels): the middle line represents a geometrical average of $n(t)$, i. e., it is a short term average of $n(t)$; the upper line is the true arithmetic average of $n(t)$. The lower half of the display shows the current number of messages in each node as a vertical line; the node numbers run from left to right. The number displayed to the left of these lines serves to calibrate the horizontal reticle (shown dotted); in this case, the upper dotted line represents 20 messages. Both calibrations are subject to change by continuously variable controls

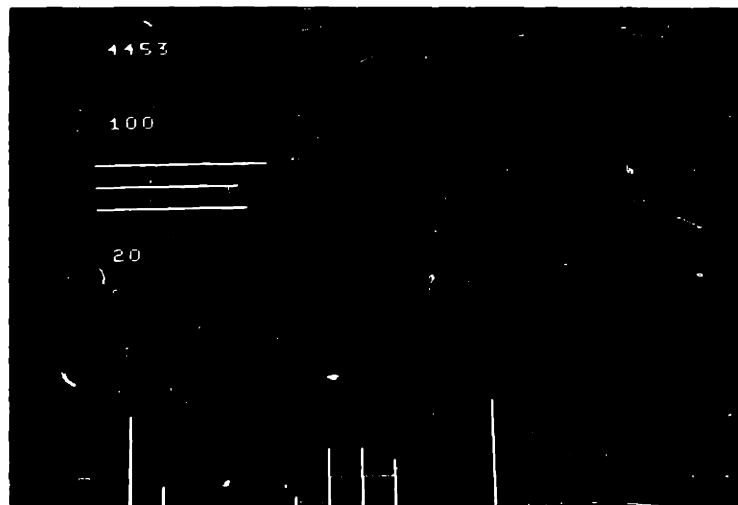

FIG. E.1 PHOTOGRAPH OF THE ON-LINE DISPLAY

on the console. In actual operation, this is a dynamic display, wherein the lengths of the solid lines are continuously changing. This gives the operator a view of the live simulation. Of course, the display can be suppressed at will by the operator.

For a 13 node net, and 10,000 messages, the total running time for the program is on the order of 2 minutes. At the termination of the run, a number of gathered statistics may then be displayed on the oscilloscope. In fact, this was chosen as the sole means of output for the program; the idea being that the desired curves could easily be photographed

and the few desired numbers could be recorded, all from the visual display.

Figures E.2(a-g) illustrate the results from a typical run. Below each figure, is a short description of the contents of the photograph.

In all of these figures, the number displayed in the upper left hand corner represents the height of the maximum data point in the figure. All displays are automatically scaled so that the maximum height lies between 2^n and 2^{n-1} where the highest scale line (all scale lines are shown dotted) has height 2^n . Thus reading quantitative data from these displays is simplified. In the displays of histograms, the mean value of the distribution represented by the histogram is displayed as a number at the top center of the figure.*

A novel feature is included in the simulation which greatly facilitates the experimental procedure. This feature allows automatic calculation of channel capacities based on the traffic carried by each channel in the previous run. For example, the channel capacity assignment described by Eq. 4.7 requires knowledge of the λ_i ; and the determination of the λ_i can be a rather tedious calculation for fixed and especially alternate routing procedures. To assign the C_i automatically, one need merely run the simulation with any C_i assignment initially; at the end of this run, each channel will have carried a particular number of messages. Based on this data, the program can then be made to calculate a new set of C_i as specified by Eq. 4.7. Of course, the total capacity distributed through the net remains fixed during this calculation. If necessary, this procedure may be repeated more than once, each time obtaining a closer approximation to the desired assignment (usually two or three iterations are sufficient); in order to decide when the correct assignment is converged upon, one need

* The number displayed in the center left region of the figure represents the number of time units which are grouped into each bar on the histogram.

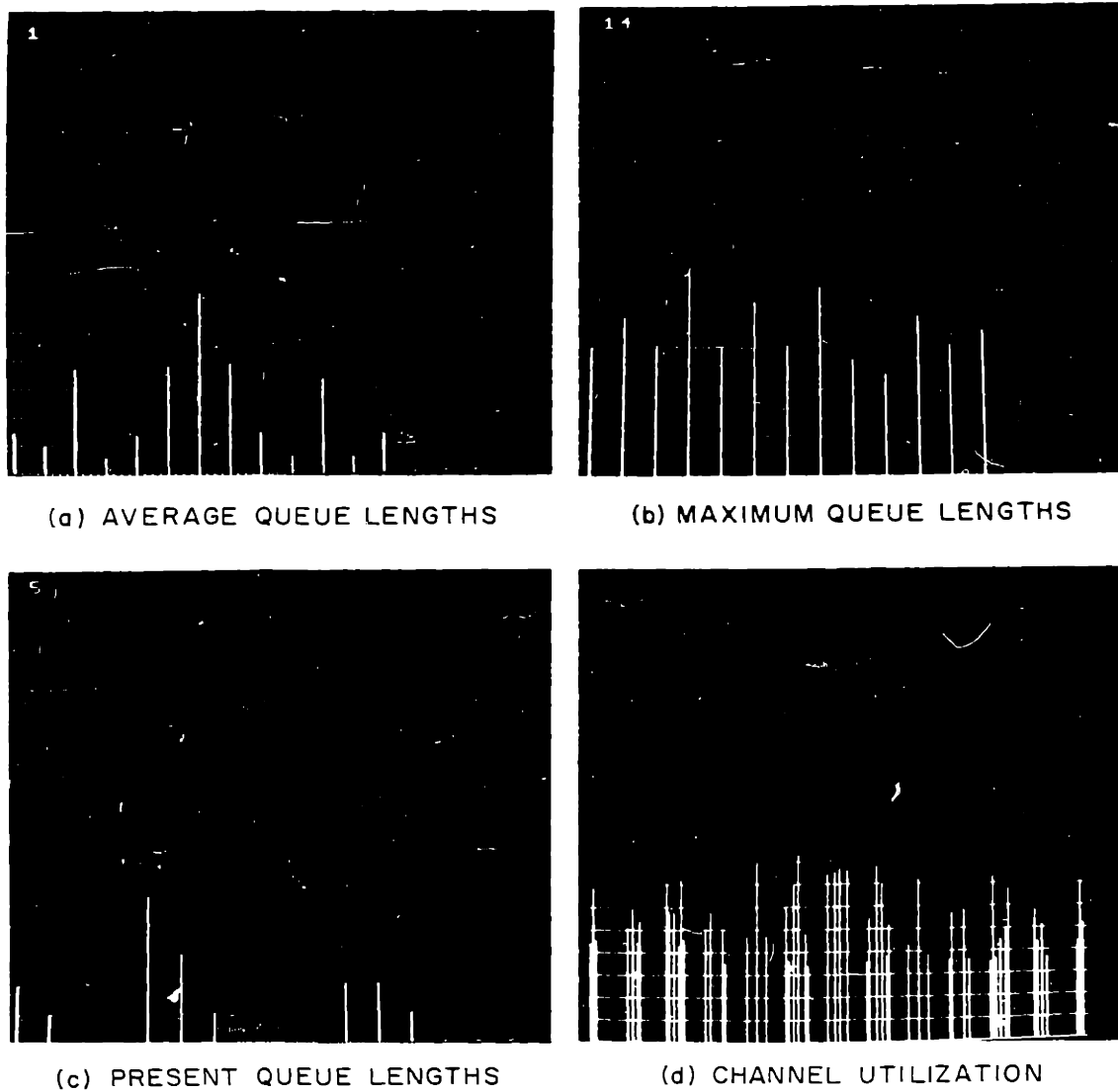
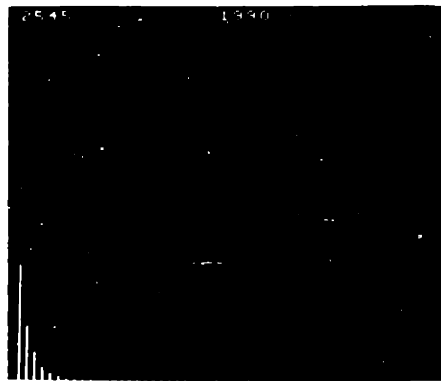

FIG. E.2 (a-d) STATISTICAL OUTPUT DISPLAY
FROM A TYPICAL SIMULATION RUN



(e) HISTOGRAM OF GENERATED MESSAGE LENGTHS



(f) HISTOGRAM OF GENERATED INTER-ARRIVAL TIMES



(g) HISTOGRAM OF TOTAL MESSAGE DELAY

FIG. E.2 (e-g) STATISTICAL OUTPUT DISPLAY FROM A TYPICAL SIMULATION RUN

merely compare the assignment for two successive runs (this information is available upon request as a printed list from a high speed printer). Furthermore, the program is designed to follow this procedure for other forms of capacity assignment which are of interest. Specifically, the following assignment is included:

$$C_i = \frac{\lambda_i}{\lambda} C \quad i = 1, 2, \dots, N^2 \quad (\text{E. 1})$$

where

$$\lambda = \sum_{i=1}^{N^2} \lambda_i$$

and C is the total capacity assigned to the net. This form of capacity assignment allocates capacity in direct proportion to the traffic carried. Also, if desired, the program will assign the same capacity to each channel. *

In summary, then, the program is equipped to simulate a large class of communication nets with different topologies, routing procedures, priority disciplines, and traffic loads. It runs quickly, generates messages automatically, and allows visual monitoring of the dynamic operation of the network; and upon termination of the run, visually displays a number of pertinent statistical distributions with quantitative scales included. Moreover, upon request, the program automatically redistributes the total capacity in the network according to one of three allocation formulae (square root, proportional, or identical capacity assignment). This last feature allows on-line experimentation and optimization of the network parameters.

* Hereafter, the capacity assignment described by Eq. 4.7 will be referred to as the square root assignment; the assignment according to Eq. E.1 will be referred to as the proportional assignment; and the capacity assignment with all capacities equal will be referred to as the identical capacity assignment.

APPENDIX F

ALTERNATE ROUTING THEOREMS AND THEIR PROOFS

F.1 Theorem 7.1 and Its ProofTHEOREM 7.1

Consider any node (say node n_1) in the network described in Sect. 7.3, from which there are two alternate paths of the same length, both paths leading to the same node (say node n_2). Then, the message delay can always be reduced by omitting one of these paths as an alternate route for messages travelling from n_1 to n_2 .

PROOF:

Assume that the number of nodes in the net is N . Further, assume that the constant length for both alternate paths between nodes n_1 and n_2 is L (i.e., a message will be transmitted over L channels successively in travelling from n_1 to n_2). Let us label the channels included in the first path by the subscript a_i and included in the second path by the subscript b_i ($i = 1, 2, \dots, L$). Let

λ_{a_i} = average total number of messages per second transmitted over the i^{th} channel of path 1.

λ_{b_i} = average total number of messages per second transmitted over the i^{th} channel of path 2.

λ_1 = average number of messages per second which are routed from n_1 to n_2 over path 1.

λ_2 = average number of messages per second which are routed from n_1 to n_2 over path 2.

See Fig. F.1. which shows the two paths extracted from a large net.

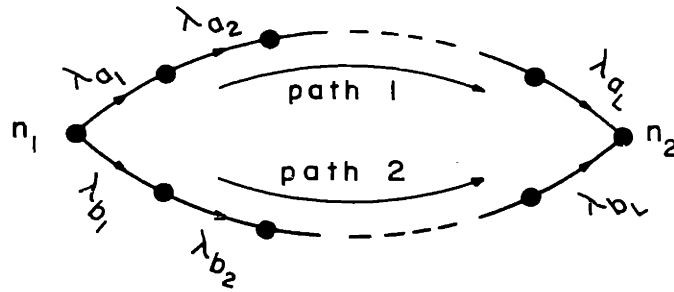

Further, let the subscript j range over all possible N^2 channels. Due to our assumptions as to the Poisson nature of the network traffic, we recognize that given the set of λ_j , the assignment of C_j which minimizes T , the average message delay, is given by Theorem 4.5. Thus, no matter which routing procedure we use, as long as we maintain independent Poisson traffic, we obtain the minimum message delay by using the square root capacity assignment.

Consider the following change to the traffic pattern

$$\lambda'_1 = \lambda_1 + \alpha$$

$$\lambda'_2 = \lambda_2 - \alpha$$

We then recognize that

$$\lambda'_{a_i} = \lambda_{a_i} + \alpha$$

and

$$\lambda'_{b_i} = \lambda_{b_i} - \alpha$$

where, of course,

$$-\lambda_1 \leq \alpha \leq \lambda_2 \quad (\text{F.1})$$

Using the square root channel capacity assignment, we find* that, for this new traffic pattern (or routing procedure),

$$T' = \frac{\bar{n} \left(\sum_{j=1}^{N^2} \sqrt{\lambda'_j} \right)^2}{\mu \lambda C (1 - \bar{n} \rho)}$$

We now inquire as to the value of α which minimizes T' , subject to the constraint in Eq. F.1. Well, clearly, minimizing T' with respect to α is the same as minimizing

$$\sum_{j=1}^{N^2} \sqrt{\lambda'_j}$$

Furthermore, the only terms in this sum which depend upon α are those for which $j = a_i$ or b_i . Thus, we find that Eq. F.2 defines the function F , which we wish to minimize.

$$F = \sum_{i=1}^L \left(\sqrt{\lambda'_{a_i}} + \sqrt{\lambda'_{b_i}} \right) \quad (\text{F.2})$$

or

$$F = \sum_{i=1}^L \left(\sqrt{\lambda_{a_i} + \alpha} + \sqrt{\lambda_{b_i} - \alpha} \right)$$

* See Eq. 4.18.

Differentiating, we find that the slope of F is

$$\frac{dF}{d\alpha} = \sum_{i=1}^L \left(\frac{1}{2\sqrt{\lambda_{a_i} + \alpha}} - \frac{1}{2\sqrt{\lambda_{b_i} - \alpha}} \right)$$

Now, it is clear that this slope is a monotonically decreasing function of α . F itself must therefore be a convex function of α , that is, for $0 \leq \beta \leq 1$, and $\alpha_1 \leq \alpha_2$,

$$\beta F(\alpha_1) + (1-\beta)F(\alpha_2) \leq F(\beta\alpha_1 + (1-\beta)\alpha_2)$$

As a result, the minimum value of F is obtained when α is at one of its extreme values ($-\lambda_1$ or λ_2). Well, if $\alpha = -\lambda_1$, then all messages travelling between nodes n_1 and n_2 will be routed along path 2; and if $\alpha = \lambda_2$, then all this traffic is routed along path 1. This proves Theorem 7.1, since either arrangement corresponds to a fixed routing procedure.

F.2 Theorem 7.2 and Its Proof

THEOREM 7.2

For the system described in Sect. 7.3, a message should accept channel C_i if and only if its position, n_i , in the queue satisfies the following inequalities

$$n_i - 1 < (S_{i-1}/C_i) - 1 \leq n_i \quad i = 2, 3, \dots, N \quad (7.2)$$

and where

$$S_{i-1} = \sum_{j=1}^{i-1} C_j \quad (7.3)$$

PROOF:

Consider a message in the queue which has just been offered channel C_i . If the

channel is accepted, it will then take, on the average, $1/\mu C_i$ seconds for this message to leave the system. Let us now assume that the message is in that position* n_i in the queue for which it makes no difference to the message's expected delay if it accepts or refuses channel C_i . Define, for $i \geq 2$,

E_i = expected time at which a message in position n_i will leave the system, if it does not accept channel C_i at time 0.

Then clearly, n_i must be such that

$$\frac{1}{\mu C_i} = E_i \quad i \geq 2 \quad (\text{F.3})$$

Furthermore, define

w_i = expected time for the message to move from position n_i to position n_{i-1} .

Now, since $\frac{1}{\mu C_i} > \frac{1}{\mu C_{i-1}}$, it is clear from Eq. F.3 and the definition of n_i that

$n_1 < n_2 < \dots < n_N$. This implies that if channel C_i is offered to the message in position

n_i , then channels C_j ($j < i$) must all be busy (i.e., in the process of transmitting other

messages). In such a case, the expected time for our message to move up one position in the queue (i.e., the expected time for any one of these $i-1$ channels to empty) must be

$\frac{1}{\mu S_{i-1}}$ (see Eq. 7.3 for S_{i-1}). Thus,

$$w_i = \frac{n_i - n_{i-1}}{\mu S_{i-1}} \quad (\text{F.4})$$

Let

$p_i = P_r$ [channel C_i empties before channels $C_{i-1}, C_{i-2}, \dots, C_1$, given that channels C_i, C_{i-1}, \dots, C_1 are all busy]

Due to the exponential message lengths,

$$p_i = \frac{C_i}{S_i} \quad (\text{F.5})$$

and

$$1-p_i = \frac{S_{i-1}}{S_i} \quad (\text{F.6})$$

* For the moment, we consider n_i to be a continuous variable.

Now, after having reached position n_{i-1} , channel C_{i-1} will empty before any other channel C_j ($j < i-1$) with probability p_{i-1} , and the message will accept this channel. On the other hand, one of the other channels, C_j will empty first with probability $1-p_{i-1}$ and then this channel will be accepted by some other message (in position n_j) ahead of our message in the queue; in this case, our message will move up to position $n_{i-1}-1$ and will spend an additional expected time $E_{i-1} - \frac{1}{\mu S_{i-2}}$ in the system. From these considerations, we write down the following recursion relation

$$E_i = w_i + p_{i-1} \frac{1}{\mu C_{i-1}} + (1 - p_{i-1}) \left[E_{i-1} - \frac{1}{\mu S_{i-2}} \right] \quad i \geq 2 \quad (\text{F.7})$$

The solution to Eq. F.7 is

$$E_i = \frac{n_i + k}{\mu S_{i-1}} \quad i \geq 2 \quad (\text{F.8})$$

This solution is easily verified by substituting into Eq. F.7, and referring to Eqs. F.4, F.5, and F.6. Referring back to Eq. F.3, we now see that

$$n_i = \frac{S_{i-1}}{C_i} - k \quad i \geq 2 \quad (\text{F.9})$$

In order to evaluate k , we recognize that n_2 must be such that

$$\frac{1}{\mu C_2} = \frac{n_2}{\mu C_1} + \frac{1}{\mu C_1}$$

or

$$n_2 = \frac{C_1}{C_2} - 1$$

and so, $k = 1$.

We now recall that n_i must be an integer, and so the condition expressed by Eq. F.9 becomes

$$n_{i-1} < \frac{S_{i-1}}{C_i} - 1 \leq n_i \quad i \geq 2$$

For $i = 1$, obviously, $n_1 = 1$. This completes the proof of Theorem 7.2.

16. Syski, R., Introduction to Congestion in Telephone Systems, (Oliver and Boyd, 1960).
17. Saaty, T.L., Elements of Queueing Theory with Applications, (McGraw-Hill 1961).
18. Riordan, J., Stochastic Service Systems, (John Wiley and Sons, 1961).
19. Morse, P.M., Queues, Inventories, and Maintenance, (John Wiley and Sons, 1958).
20. Burke, P.J., The Output of a Queueing System, Operations Research, 4 p.699 (1956).
21. Foster, F.G., A Unified Theory for Stock, Storage and Queue Control, Operations Research Quarterly, 10 p.121 (1959).
22. Hunt, G.C., Sequential Arrays of Waiting Lines, Operations Research, 4 p.674 (1956).
23. Jackson, J.R., Networks of Waiting Lines, Operations Research, 5 p.518 (1957).
24. Prosser, R.T., Routing Procedures in Communications Networks, Part 1: Random Procedures, Lincoln Laboratory internal report No. 22G-0041 (1960); to be published in the I.R.E. Transactions of the Professional Group on Communication Systems.
25. Prosser, R.T., Routing Procedures in Communications Networks, Part II: Directory Procedures, Lincoln Laboratory internal report No. JA-2006 (1962); to be published in the I.R.E. Transactions of the Professional Group on Communication Systems.
26. Pollack, M., and W. Wiebenson, Solutions of the Shortest Route Problem - A Review, Operations Research, 8 p.224 (1960).
27. Jewell, W.S., Optimal Flow Through a Network, M.I.T. Sc.D. Thesis (Electrical Engineering Department), (1958).
28. Chien, R.T., Synthesis of a Communication Net, I.B.M. internal report No. E.S. -0017 (1960).
29. Gomory, R.E., and T.C. Hu, Multi-Terminal Network Flows, I.B.M. internal report No. RC-318 (1960).
30. Elias, P., A. Feinstein, and C.E. Shannon, A Note on the Maximum Flow Through a Network, Transactions, I.R.E., IT-2 p.117 (1956).

31. Prihar, Z., Topological Properties of Telecommunication Networks, Proc. I.R.E., 44 p.927 (1956).
32. Moran, P.A.P., The Theory of Storage, (London: Methuen and Co. Ltd., New York: John Wiley and Sons, 1959).
33. Shannon, C.E., and W. Weaver, The Mathematical Theory of Communication, (The University of Illinois Press, 1949).
34. Phipps, T.E., Jr., Machine Repair as a Priority Waiting-Line Problem, Operations Research, 4 p.76 (1956).
35. Cobham, A., Priority Assignments in Waiting Line Problems, Operations Research, 2 p.70 (1954).
36. White, H., and L.S. Christie, Queueing with Pre-emptive Priorities or with Breakdown, Operations Research, 6 p.79 (1958).
37. Jackson, J.R., Some Problems in Queueing with Dynamic Priorities, Naval Research Logistics Quarterly, 7 p.235 (1960).
38. Jackson, J.R., Waiting Time Distributions for Queues with Dynamic Priorities, Naval Research Logistics Quarterly, 9 No. 1, p.31 (1962).
39. Frankovich, J.M., and H.P. Peterson, A Functional Description of the Lincoln TX-2 Computer, Proc. of the Western Joint Computer Conference, p.146, (February 26-28, 1957).
40. Morse, P.M., Stochastic Properties of Waiting Lines, Operations Research, 3 p.255 (1955).
41. Kendall, D.G., Some Problems in the Theory of Queues, J.R.S.S. Ser.B 13 p.151 (1951).
42. Burke, P.J., The Output of a Queueing System, Operations Research, 4 p.699 (1956).
43. Hildebrand, F.B., Methods of Applied Mathematics, (Prentice-Hall, Inc., 1958).
44. Little, J.D.C., A Proof for the Queueing Formula $L = \lambda W$, Operations Research, 9 p.383 (1961).
45. Lindley, D.V., Theory of Queues with a Single Server, Proc. Cambridge Phil. Soc., 48 No. 2, p.277 (1952).
46. Kemperman, J.H.B., The Passage Problem for a Stationary Markov Chain, (University of Chicago Press, 1961).

BIOGRAPHICAL NOTE

Leonard Kleinrock was born in New York City on June 13, 1934. After graduating from the Bronx High School of Science and Mathematics in 1951, he enrolled in the evening session of the City College of New York. In 1957, he was awarded the degree of Bachelor of Electrical Engineering, magna cum laude, from C.C.N.Y., and received the Electrical Engineering Award. In 1959, he received the degree of Master of Science in Electrical Engineering from the Massachusetts Institute of Technology while participating in the Lincoln Laboratory Staff Associate program. He continued in that program while pursuing his doctorate study.

From 1951 to 1957, he was in full time employ at the Photobell Company, Inc., an industrial electronics firm. He spent the summers from 1957 through 1961 at Lincoln Laboratory, first in the Digital Computer group and later in the Systems Analysis group. At M.I.T., the academic years were spent initially at the Electronic Systems Laboratory (formerly named the Servomechanisms Laboratory) and then at the Research Laboratory of Electronics in the Information Processing and Transmission group; during this period, he spent some time teaching a course in Electronic Circuit Theory.

Mr. Kleinrock is a member of Tau Beta Pi, Sigma Xi, Eta Kappa Nu, the Institute of Radio Engineers, and the Operations Research Society of America. He presented a paper entitled "Optical Information Processing with Thin Magnetic Films" which may be found in the Proceedings of the National Electronics Conference, Vol. 14 pp. 789-797 (1958).

In 1954, he married the former Gail Ann Jacoby of New York City. They have two wonderful children, Martin Charles (1958) and Nancy Sarah (1960).